



 **User Manual**

# PHOTON MONO X

Dear customer,

Thank you for choosing **ANYCUBIC** products.

Maybe you are familiar with 3D printing technology or have purchased **ANYCUBIC** printers before, we still highly recommend that you read this manual carefully. The installation techniques and precautions in this manual can help you avoid any unnecessary damage or frustration.

More information please refer to :

1. <http://www.anycubic.com/>

**ANYCUBIC** website provides software, videos, models, after-sale service, etc.

Please visit our website for technical support and we are likely to answer or solve all the questions for you!

2. Facebook page and Youtube channel as shown below.



**ANYCUBIC** Website



Facebook page



Youtube channel

Team **ANYCUBIC**

Copyrighted by "Shenzhen Anycubic Technology Co., Ltd ", all rights reserved.

# Safety Instructions

*Always follow the safety instructions during assembly and usage, to avoid any unnecessary damage to the 3D printer or individual injury*



Please contact our customer service first if you have any issue after receiving the products.



Be cautious when using the scraper. Never direct the scraper towards your hands.



In case of emergency, please immediately cut off the power of **ANYCUBIC** 3D printer and contact the technical support.



**ANYCUBIC** 3D printer includes moving parts that can cause injury.



It is recommended to use protection glasses when cleaning/sanding the printed models to avoid small particles contacting eyes.



Keep the **ANYCUBIC** 3D printer and its accessories out of the reach of children.



Vapors or fumes may be irritating at operating temperature.

Always use the **ANYCUBIC** 3D printer in an open and well ventilated area.



**ANYCUBIC** 3D printer must not be exposed to water or rain.



**ANYCUBIC** 3D printer is designed to be used within ambient temperature ranging 8°C-40°C, and humidity ranging 20%-50%. Working outside those limits may result in low quality printing.



Do not disassemble **ANYCUBIC** 3D printer, please contact technical support if you have any question.

# Contents

1. Technical Specification .....	1
2. Packing List .....	3
3. Product Overview .....	4
4. Menu Directory .....	5
5. Assembly and Leveling Instructions .....	8
6. First Print Instructions .....	12
7. Slicing Software .....	15
8. FAQ and Machine Maintenance .....	49

# Technical Specification

---

## Printing

System	ANYCUBIC Photon Mono X
Operation	3.5-inch Color TFT Screen
Software	ANYCUBIC Photon workshop
Connectivity	USB memory stick

## Specifications

Technique	LCD Shadow Masking
Light source	UV-LED (wavelength 405nm)
XY Resolution	0.050mm 3840*2400 (4K)
Z axis Accuracy	0.01mm
Suggested Layer Thickness	0.01 ~ 0.15mm
Suggested Print Speed	MAX 60mm/h
Rated power	120W

## Physical Dimensions

Dimension	270mm (L) *290mm (W) 475*mm (H)
Build volume	192mm (L) *120mm (W) *245mm (H)
Materials	405nm UV-resin
Net weight	~10.75 kg

# Technical Specification

## Recommended Printing Parameters

Layer Thickness	0.05 mm
Normal Exposure Time	2 (for the transparent color resin, it is 2s; for others, such as grey, black, white and skin color resin, it is 1.5s )
UV power	50%(for the transparent color resin, it is 50%; for others, such as grey, black, white and skin color resin, it is 80% )
Off Time	0.5 s
Bottom Exposure Time	40 s
Bottom Layers	6
Z Lift Distance	8 mm
Z Lift Speed	2 mm/s
Z Retract Speed	3 mm/s
Anti-alias	1









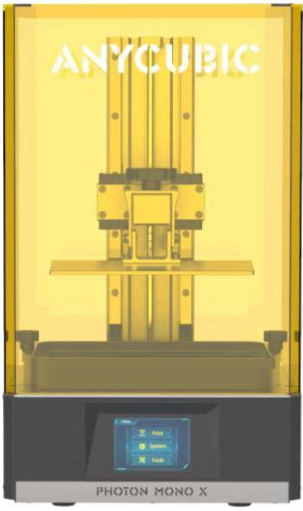
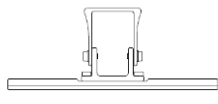
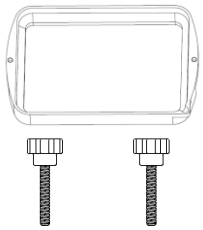

### Note:

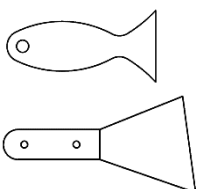
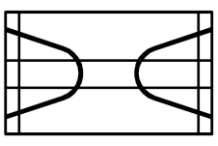
1.The recommended printing parameters above is for reference only, which is more suitable for Anycubic resin. If you use other resin, please refer to the recommended printing parameters supplied by its manufacturer or print "R\_E\_R\_F" to test.

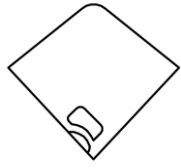
2. The UV power of the machine is high. If there are solid residue in the resin vat or on the printing platform frequently, please decrease the UV power and increase the normal exposure time.



# Packing List

			
		<p>Print platform 1PCS</p>	<p>Resin vat 1PCS</p>
			
<p>Photon Mono X</p>		<p>USB memory 1PCS</p>	<p>Scrapers 2PCS</p>
			
<p>Mask 1PCS</p>	<p>Gloves 3Pairs</p>	<p>Funnel 5PCS</p>	<p>Assembly Instruction 1PCS</p>
			
<p>Power adaptor / Power cord 1PCS</p>	<p>After-sale service card 1PCS</p>	<p>Tool kit</p>	<p>WIFI Antenna 1PCS</p>
			
<p>Leveling paper 1PCS</p>			

# Product Overview

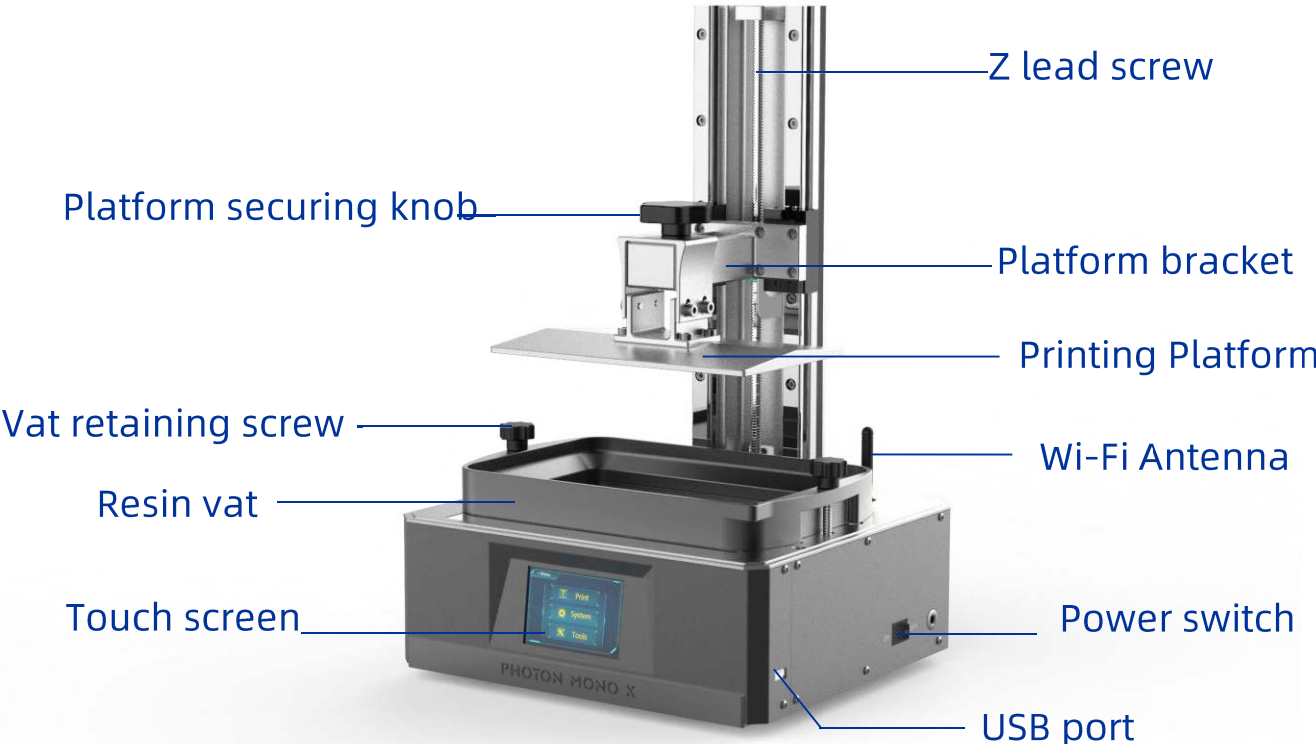



# Menu Directory

## Home menu



Print

System

Tools



## Home menu



Enter the Print Menu

Enter the System Menu

Enter the Tools Menu

# Menu Directory

## Print

### File List:

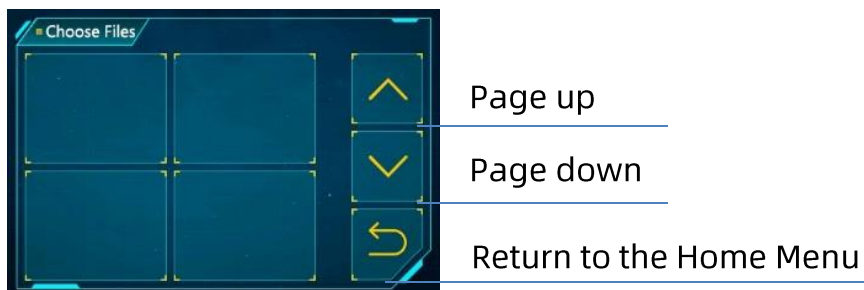

### Click Files



## System

**Language:** Change language(English/Chinese)

### Service:

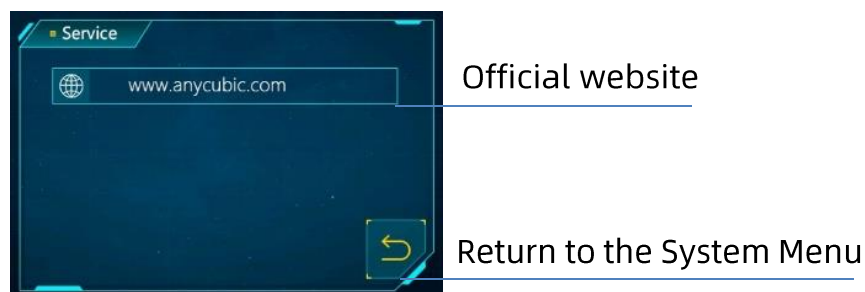

### Information:

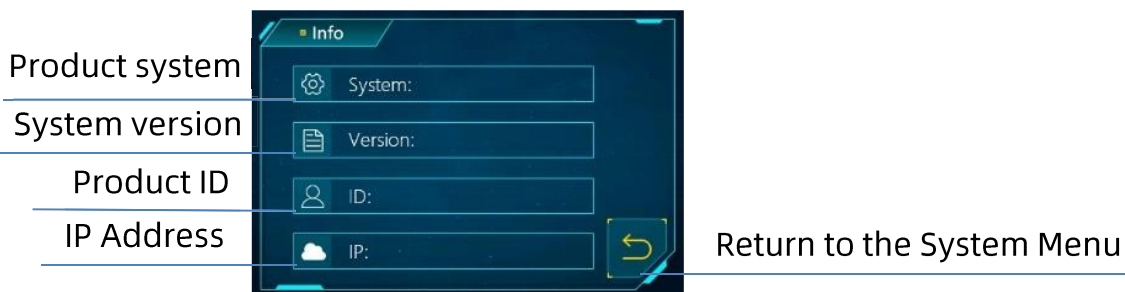

# Menu Directory

## Tools

### Move Z:



The screenshot shows the 'Move Z' menu with the following buttons and labels:

Move the Z axis downwards	0.1mm	1mm	10mm	Move Z by 0.1 mm/1mm/10mm
Move the Z axis upwards	Up arrow	Down arrow	Home icon	Return to Zero
Stop moving the Z axis	Stop icon	Z = 0	Return icon	Return to the Tools Menu

Reset the zero point

### Detection:

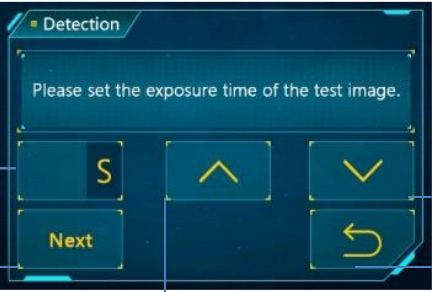

The screenshot shows the 'Detection' menu with the following buttons and labels:

Click to set the test time	S	Up arrow	Down arrow	Reduce the test time
Test LED and LCD for the preset time	Next		Return icon	Return to the Tools Menu

Increase the test time

### Exposure:



The screenshot shows the 'Exposure' menu with the following buttons and labels:

Click to set the exposure time	S	Image selection icon	Image selection icon	Select one of the images to expose
Expose for the preset time	Next	Image selection icon	Return icon	

**Lock icon:** Enable/disable the door detection function

**Horn icon:** Turn on/off the screen sound

**Gear icon:** Enter to set the UV power (30% ~ 100%)

# Assembly and Leveling Instructions

1. Unpack the machine and take out the accessories. Then plug in the power cord and turn on the printer.



2. Click “Tools” → “Move Z” → “10mm” on the touch screen to raise Z axis.

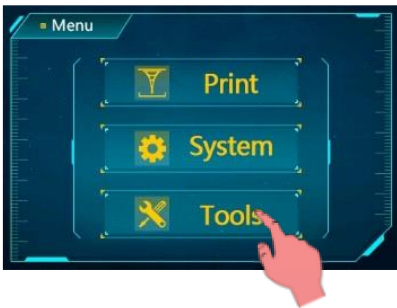

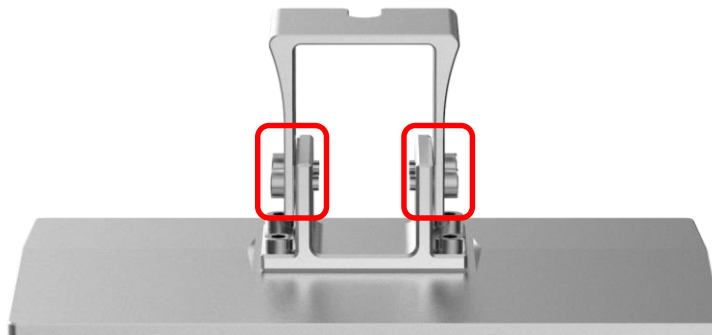

3. Unscrew four screws on the platform.

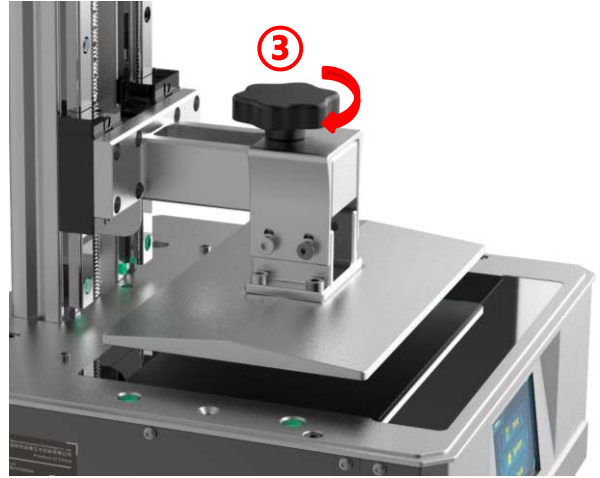
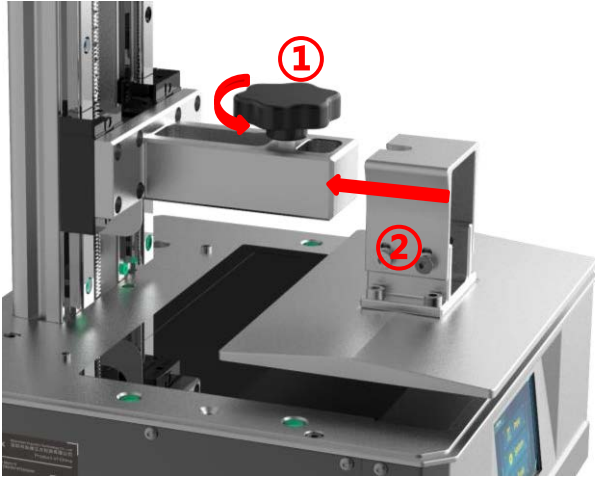

# Assembly and Leveling Instructions

4. Install the printing platform.



5. Place the leveling paper on the curing screen. Then click the “Tools” → “Move Z” → “” on the color screen. Wait for the Z axis to descent and then it will stop automatically.

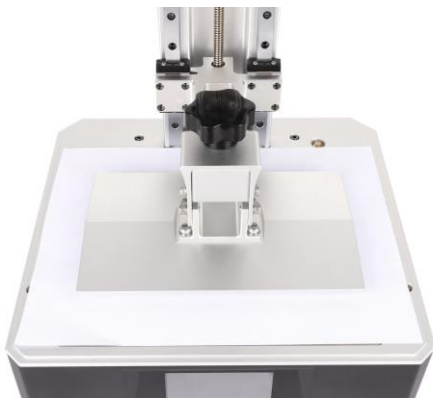

6. Now press on top of the platform gently, to let it fit evenly on the curing screen. Then tighten the four screws on the platform.

# Assembly and Leveling Instructions



7. Lastly, click “Z=0” on the touch screen, and then click “Enter” on the pop-up window. Till now, the leveling process is finished. Click “Enter” again and pull out A4 paper.

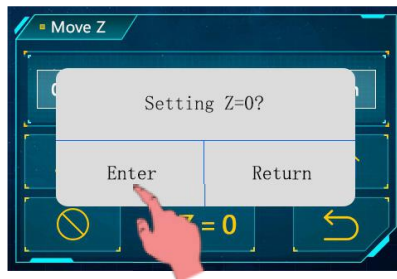

8. Testing UV light: Click “Tools”→ “Detection”, select the testing time, and then click “Next” on the screen. The curing screen should display a complete image as shown below. Otherwise, the UV light is malfunction and please contact the tech support.

Click here to set the test time

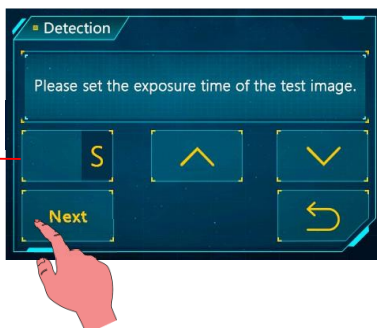

# Assembly and Leveling Instructions

9. Install the resin vat.

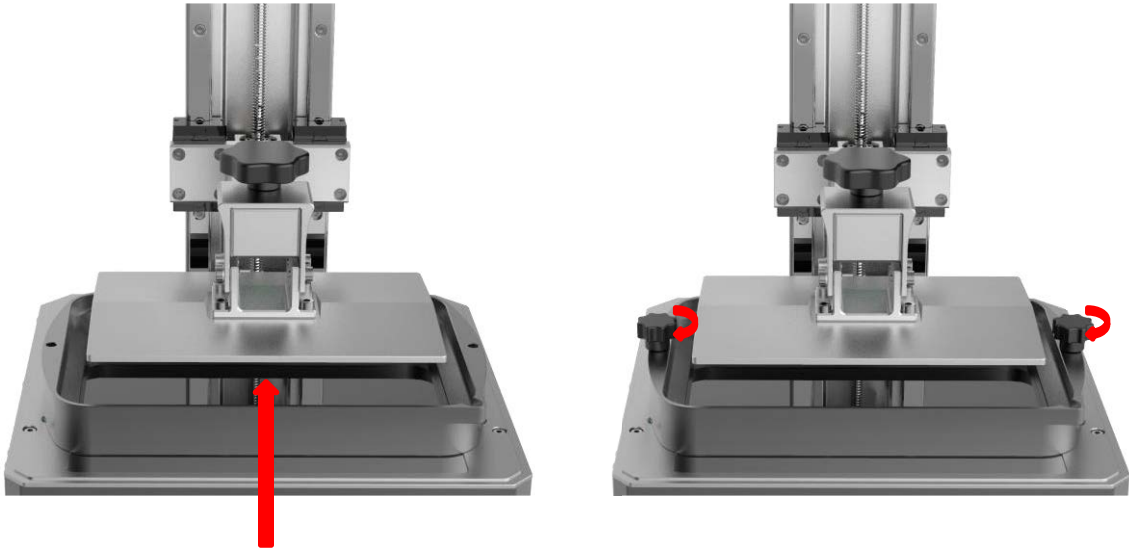

10. Install the Wi-Fi antenna.

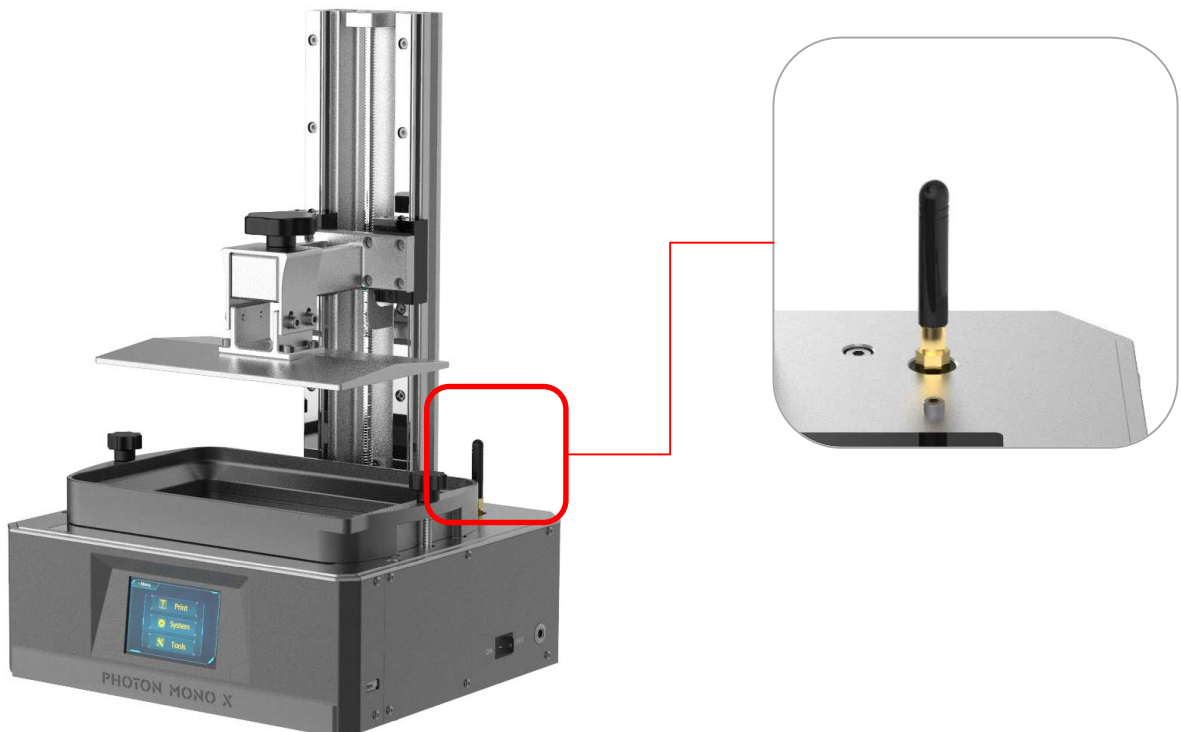

# First Print Instructions

## 1. Print

Insert the USB memory (the test file "TEST.pwmx" has been saved in it) into the USB port. **Then wear masks and gloves**, slowly pour the resin into the vat and be careful not to exceed the maximum scale of the vat. After that, cover the lid and the side with sticker needs to face backward. Take off the gloves, select the "TEST.pwmx" test file and start printing.

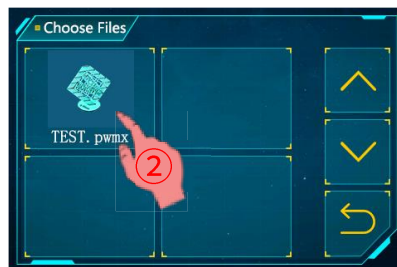
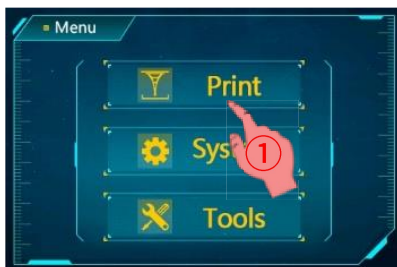

If you think the resin is insufficient to finish an ongoing print (or you wish to change the resin color), you can click "Pause", the platform will rise, and you can slowly pull (or change) the resin into the vat. After that, click "Start" to resume.



click to pause



click to start



# First Print Instructions

## 2. Door detection function

Door detection function is disabled by default. If this function is enabled, the printer can detect whether the lid is on or not. If the lid is removed, the printing will be paused. And the printing will resume if put back the lid.

Click the lock icon on “Tools” interface to enable/disable this function.

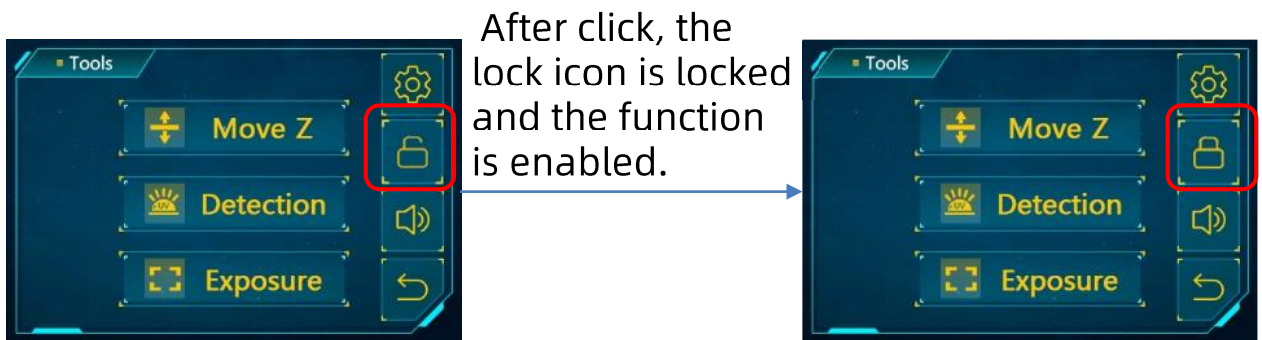

## 3. Set the UV power

There are two ways to set the UV power.

Before printing, click “Tools”→ “”. Then click “UV power” in the Set up interface to set the UV power.

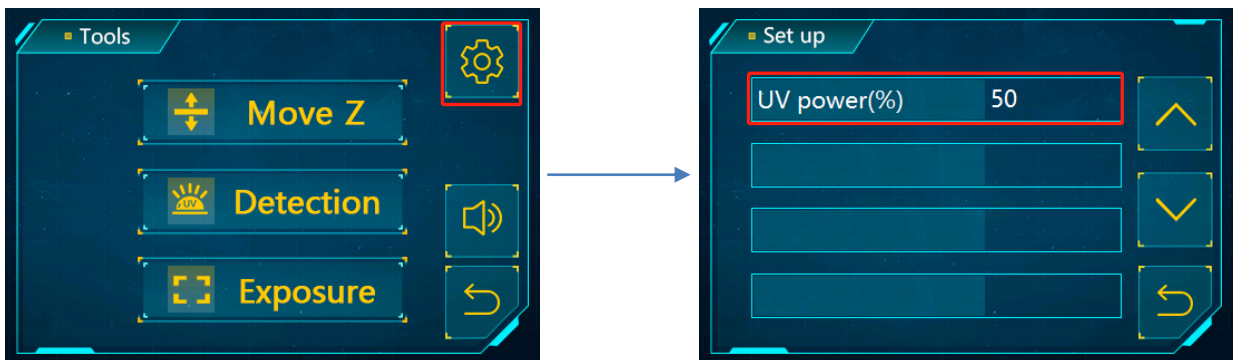

Besides, in the process of printing, you can click “” in Print interface, and page down to find “UV power”. Then click it to set the UV power.

# First Print Instructions

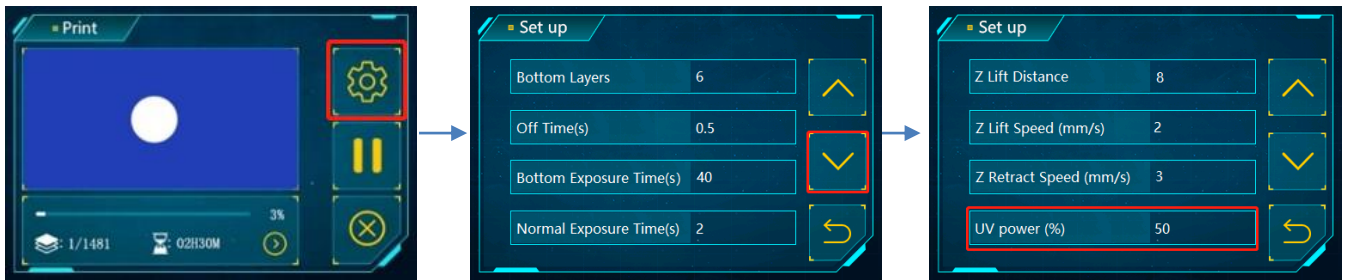

## 4. Handling models and residues

After printing, wait until the resin stop dropping from the platform and then unscrew and remove the platform. The model can be removed by scraper carefully. The removed model should be washed with ethanol 95vol% concentration. The printed model may need post curing to achieve better hardness by direct **sunlight** or UV-curing box.

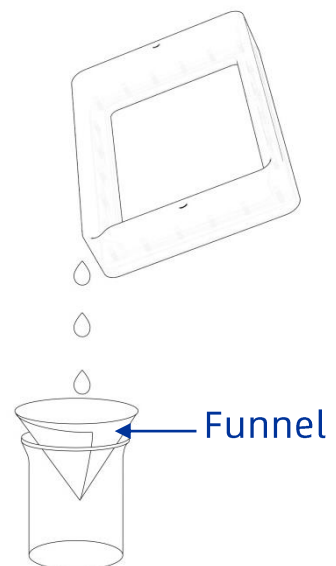
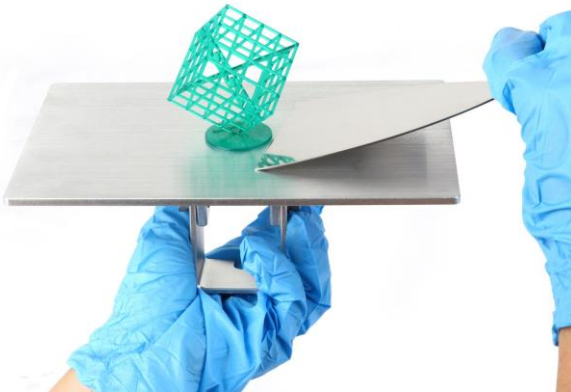

# Slicing Software

Photon Mono X 3D printer reads "pwmX" file and prints. It is necessary to convert 3D files (such as stl. file or obj. file) into pwmX files for machine to recognize. Software that convert 3D files into pwmX files is called slicing software.

## 1. Slicing software installation

Here Windows PC is taken for example. Slicing software is located in "File\_English\_Photon Mono X" in memory stick. (You may have to close the anti-virus software before installing the slicing software.) Double click "Photon\_WorkShop\_ V2.1.24.exe", and then follow the installation guide as shown below:

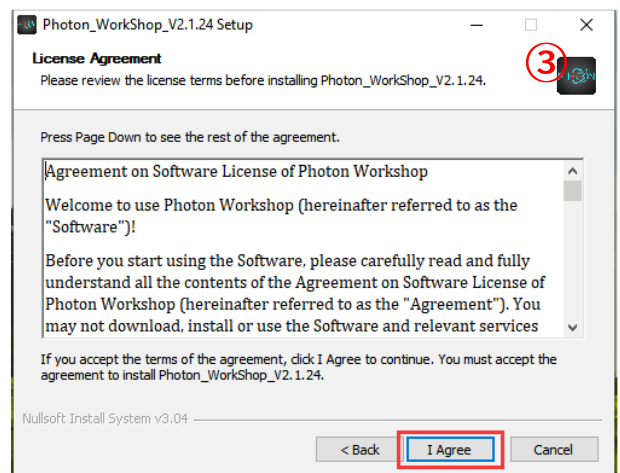
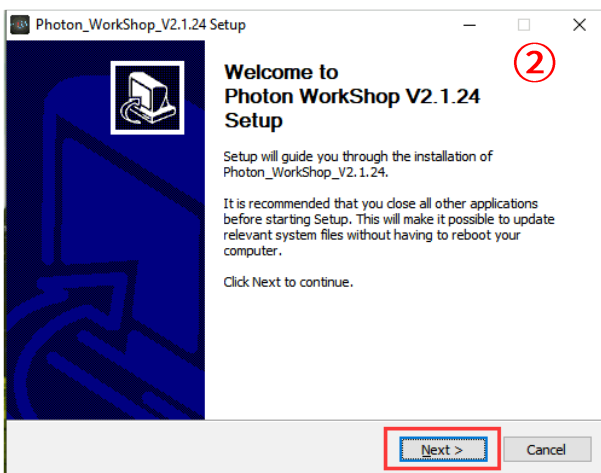
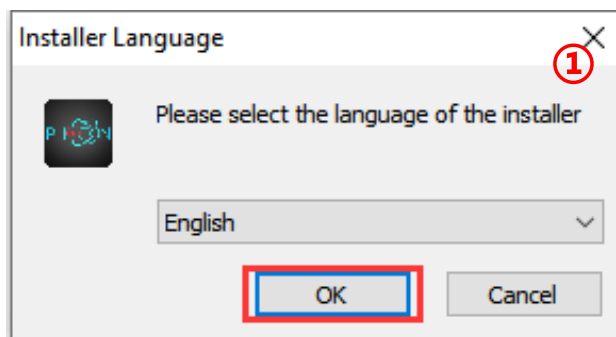

# Slicing Software

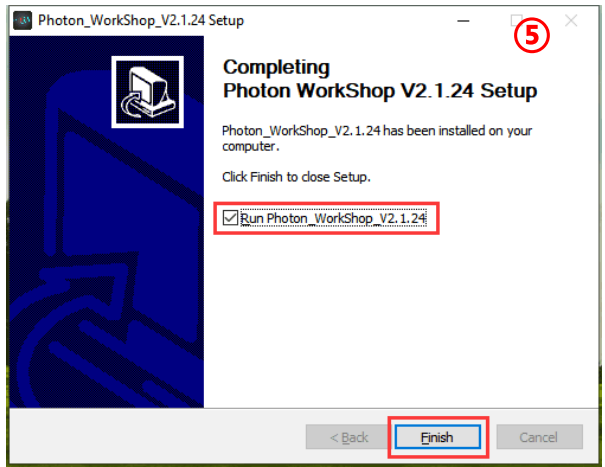
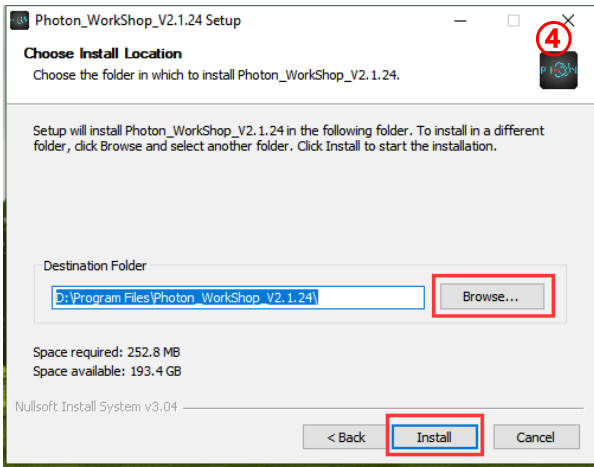

For Mac PC, double click “Photon\_WorkShop\_V2.1.24.dmg” to install the slicing software and follow the pop-up messages.

**Note: ANYCUBIC may update the software and firmware without notification. Please visit [www.anycubic.com](http://www.anycubic.com) for the latest updates.**

## 2. Photon Workshop

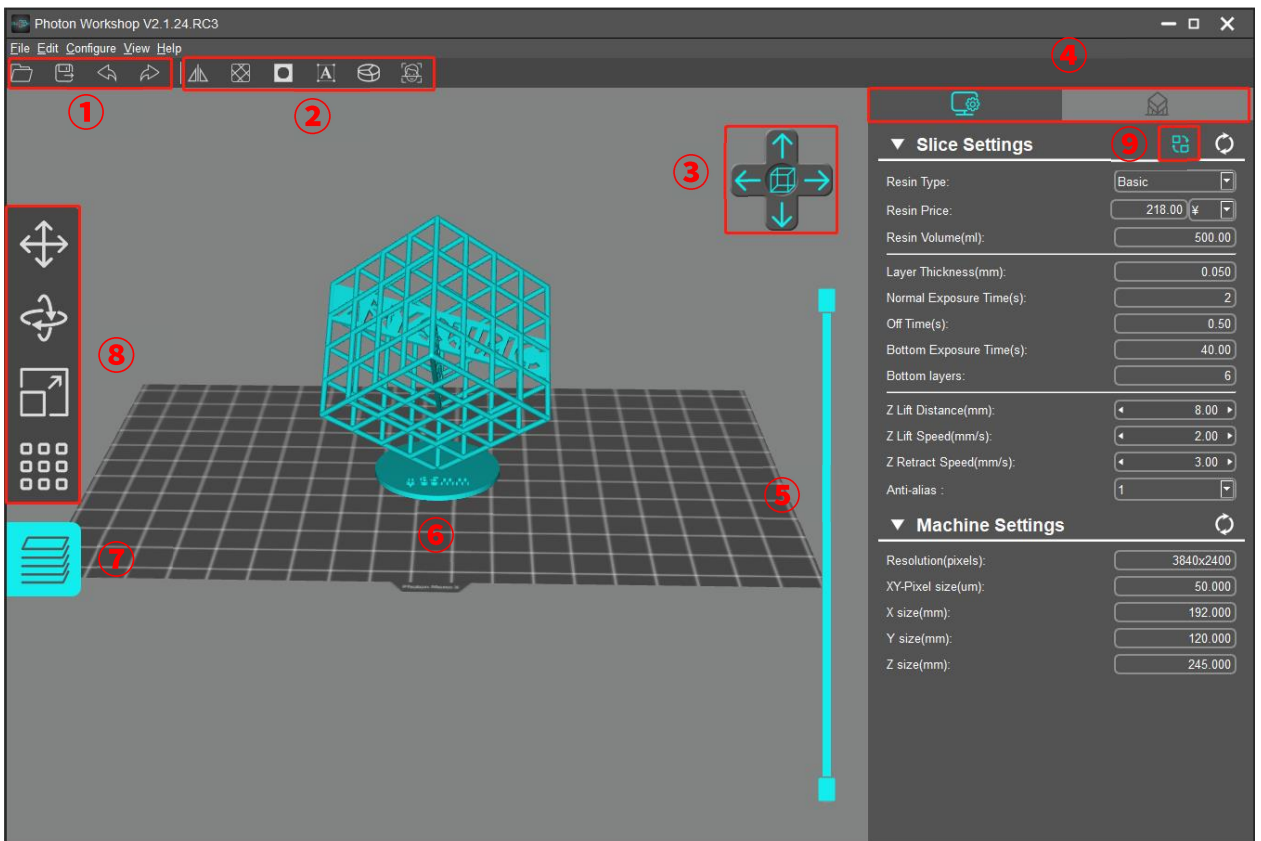

# Slicing Software

- ① Open, save, undo and redo.
- ② Model mirror, hollow and infill, punching, text paste and spilt model - explained in the following parts.
- ③ Click to switch the preset view.
- ④ Switch between slice/machine settings and support settings.
- ⑤ Drag the slider to preview each layer of the model.
- ⑥ 3D model preview.
- ⑦ Click to slice.
- ⑧ Move, rotate, scale and layout.
- ⑨ Click to switch to the AutoConfig Mode.

## 3. Manipulate 3D model in Photon Workshop

### (1) Model Importing

After software has been installed, please run it first. On the menu bar, Click “Configure” → “Machine Type” → “Photon Mono X”.

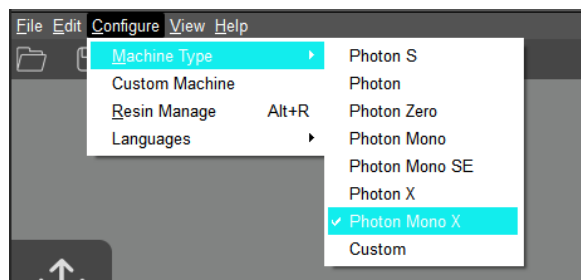

Note: Different machine types have different printing parameters. Users need to choose the correct machine.

On the menu bar, click “File” → “Open file” (or click the “Open” icon at the top left (red square)) to import your own three-dimensional format model, i.e. STL file or OBJ file. Or you may input the test file (TEST.stl) in the memory stick.

# Slicing Software

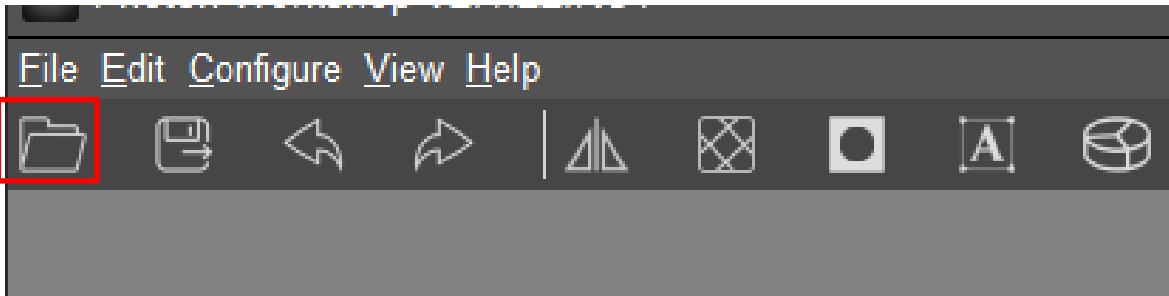

## (2) View Changing

### ① View changing by mouse

- Zoom in/out: scroll the mouse wheel.
- Position change: left click the platform, hold on and move the mouse.
- Change view angle: right click the platform, hold on and move the mouse.

② View changing by interface controls: click the arrow can change the viewing angle by 90° in its direction.

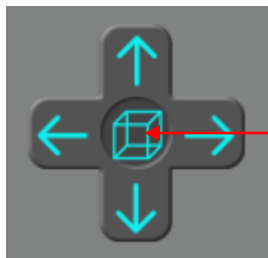

Click the center icon and the view will be automatically zoomed in. Click again to show the top view.

# Slicing Software

## (3) Model Changing



**Move selected:** click “move” icon, input a number or manipulate the controls can move the model. You also can center or reset the model.

**Rotate selected:** click “rotate” icon, input a number or manipulate the controls can rotate the model. You also can reset the model.

**Scale selected:** click “scale” icon, input a number or percentage or manipulate the controls can scale the model. You also can set the model to its maximum size.

**Layout models:** click “layout” icon, you can duplicate the model and arrange the models in X or Y direction.

### ① Model moving

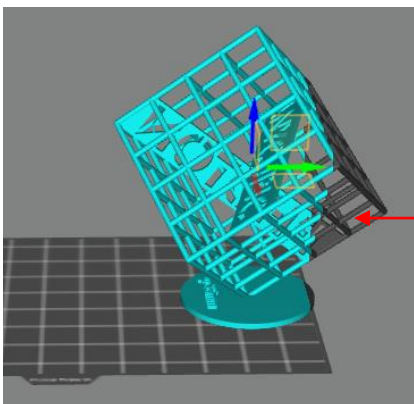

**NOTE:** The part out of the print range will turn dark grey, which is not printable.

# Slicing Software

- ② **Model rotating:** Choose a larger facet as the ground fitting platform, which can improve print success rate.

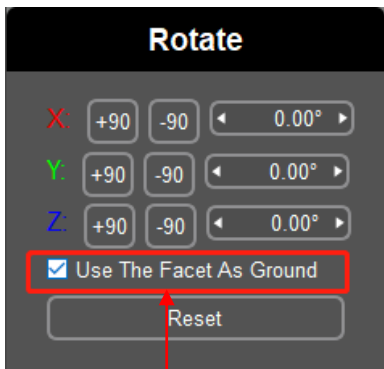

Check off

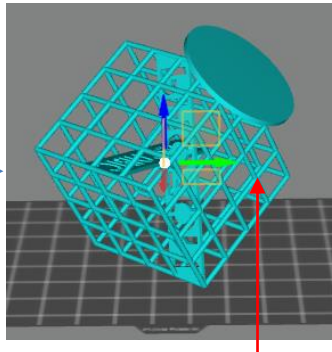

Click on the larger bottom of the model.

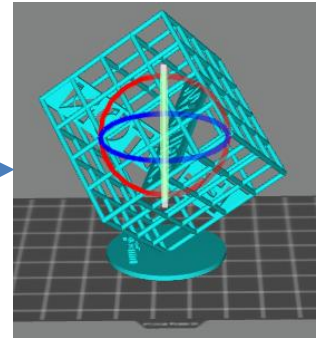

- ③ **Model scaling**

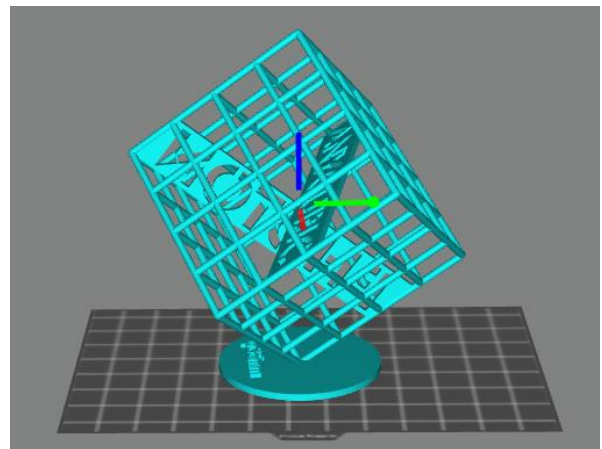
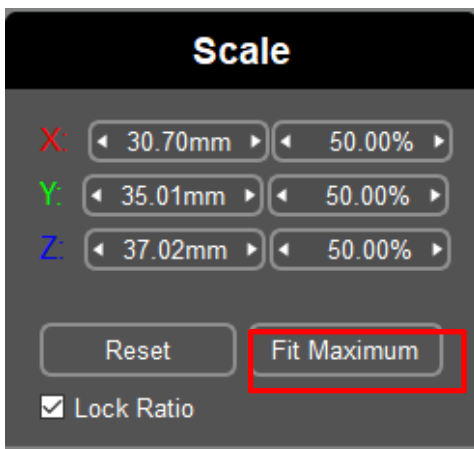

After setting the model to the maximum size, center it to avoid the model exceeding the print range.



# Slicing Software

- Center the model:

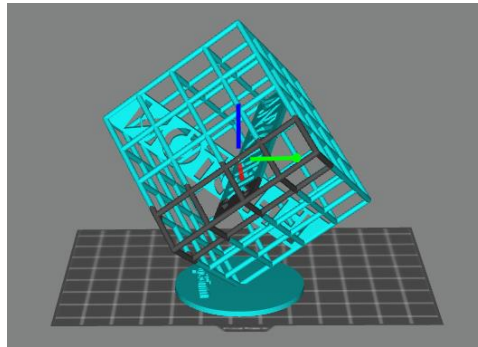

Fix Maximum

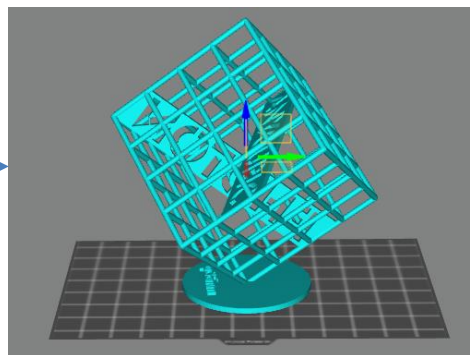
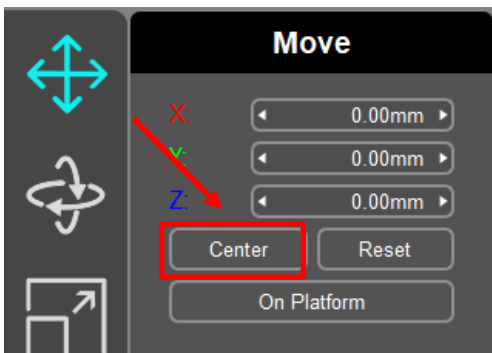

## ④ Layout

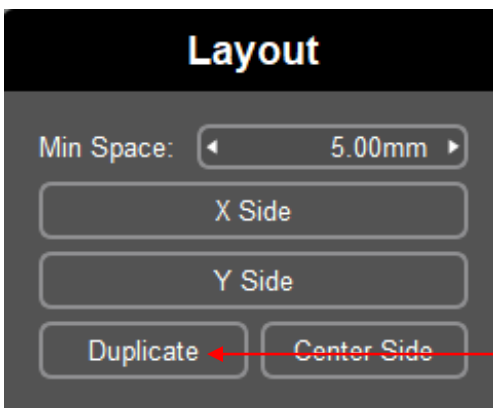

Select the model and click "Duplicate", then an identical model will be duplicated. (Those models may overlap)

For multiple models, click "X Side" or "Y Side", the models can be aligned in X or Y direction.

# Slicing Software

## (4) Hollow And Fill

In some cases, you don't need the model to be completely solid. Before you start slicing a model, you can hollow to reduce resin consumption.

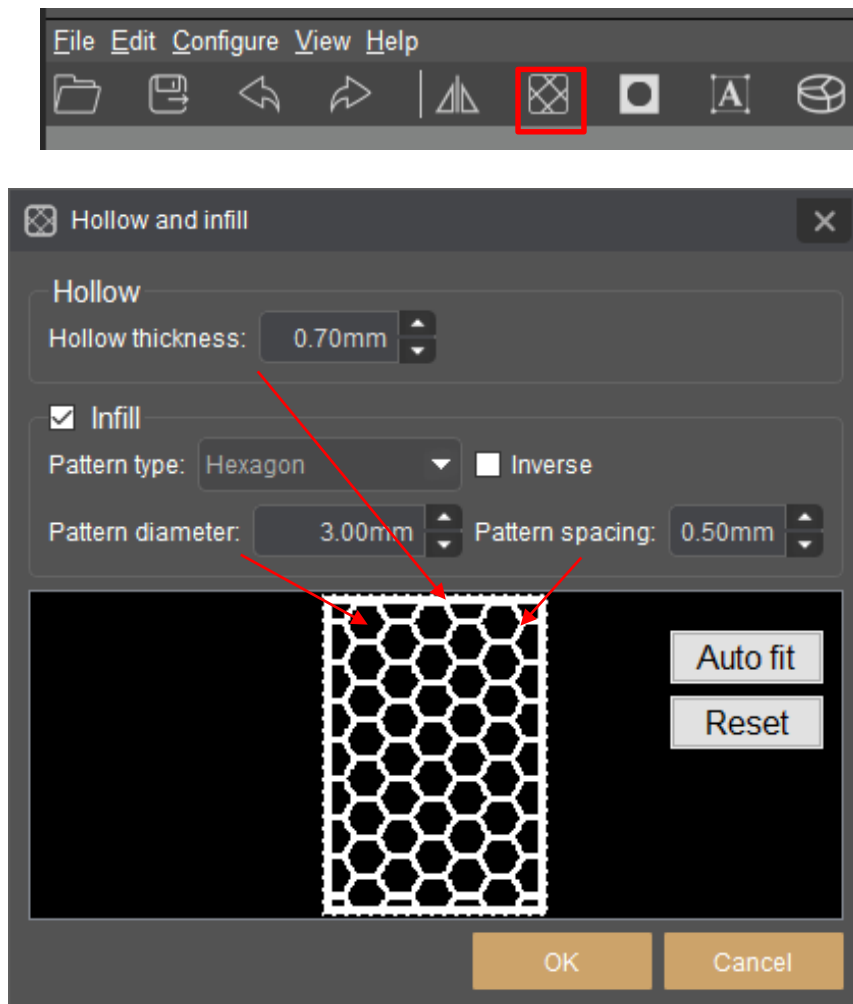

Please check and choose the most suitable parameters for hollowing and infilling to fit your requirement.

# Slicing Software

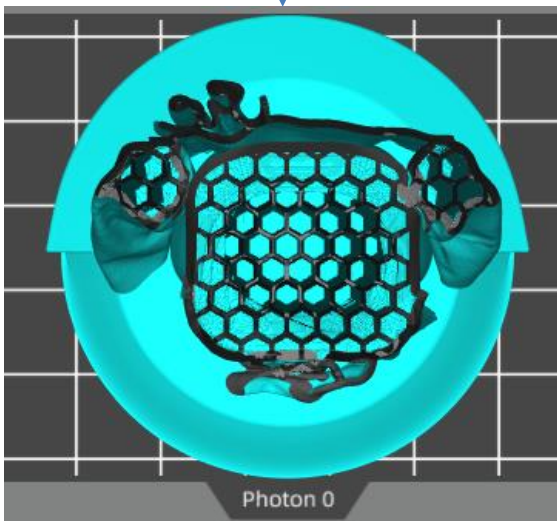
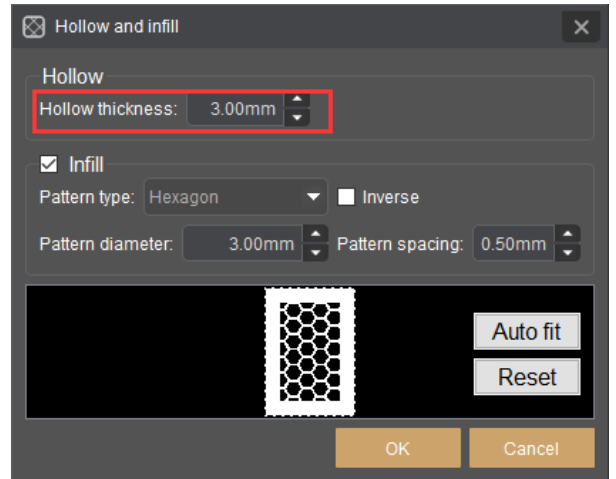
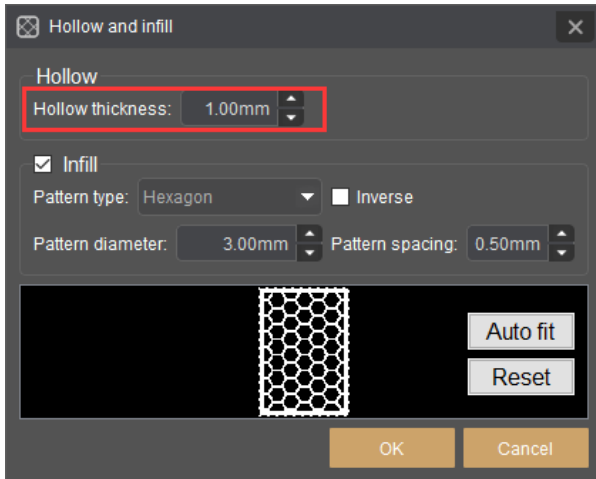

Hollow thickness: 1mm

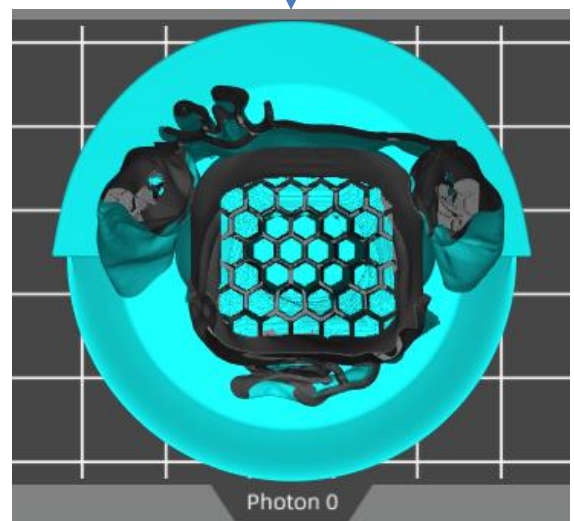

Hollow thickness: 3mm



The model name: MIA

The author of the model: Fabio Nishikata

You may drag the slider to see the internal structure of the model after hollowing.

# Slicing Software

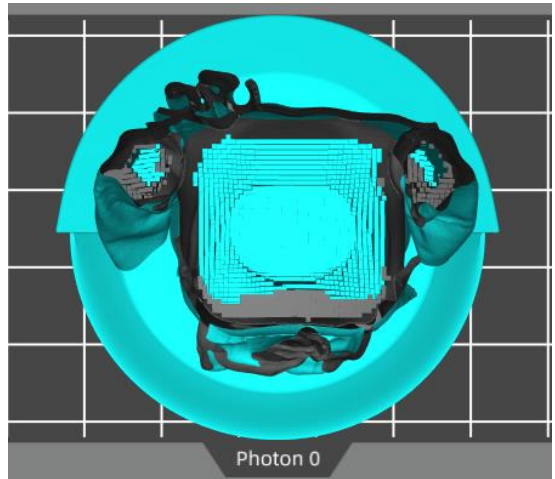
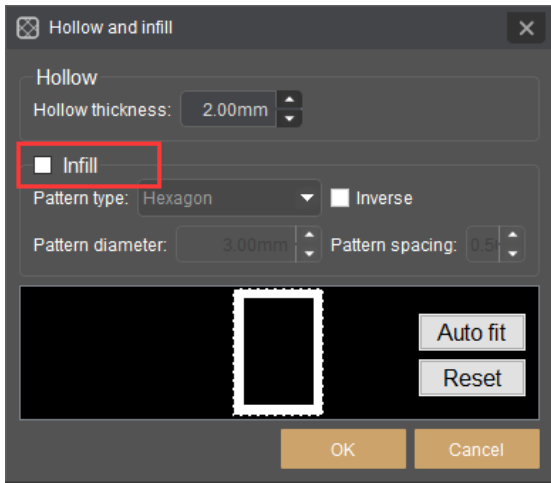

Hollow thickness: 2mm, no infill

## (5) Punching

Although the model is hollowed, there will still be part of the resin remaining in the model after printing. By punching the model, the resin in the model can flow out, which reduces the weight of the model and the resin consumption.

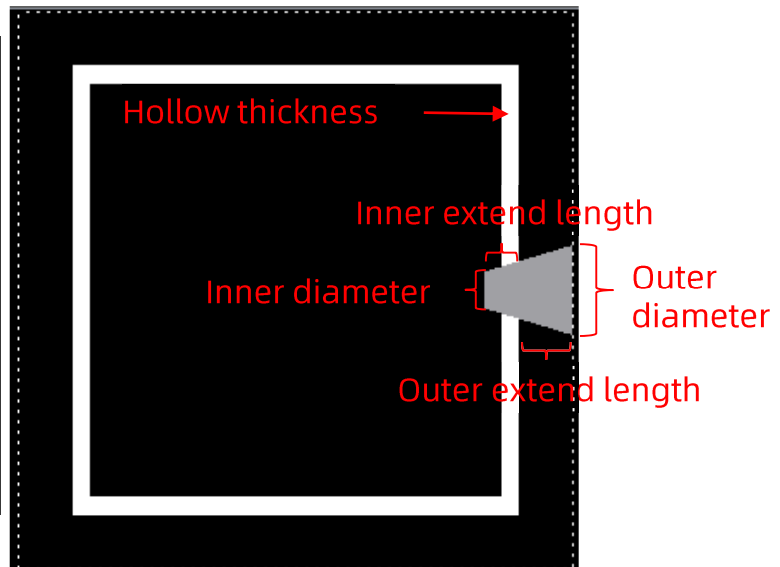
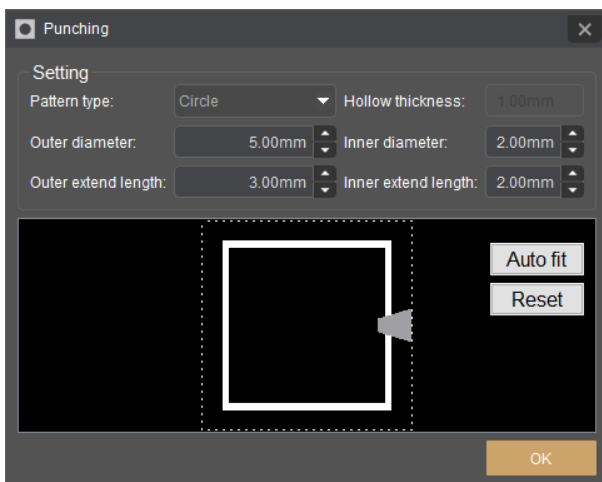
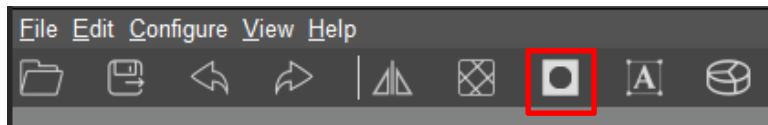

The "Inner extend length" must be greater than the "Hollow thickness", so that the model can be pierced when punching and the resin can flow out of the model.

# Slicing Software

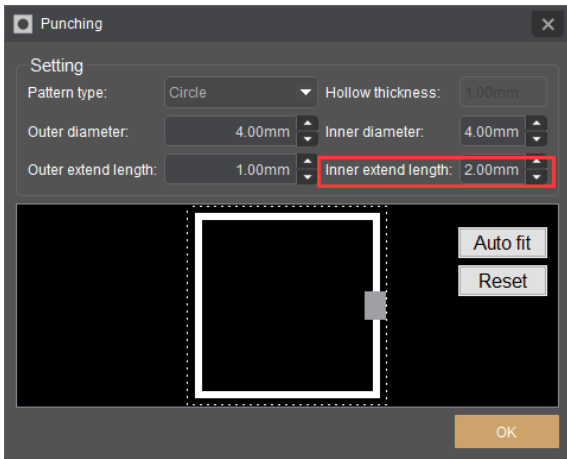

Set the parameter of the hole

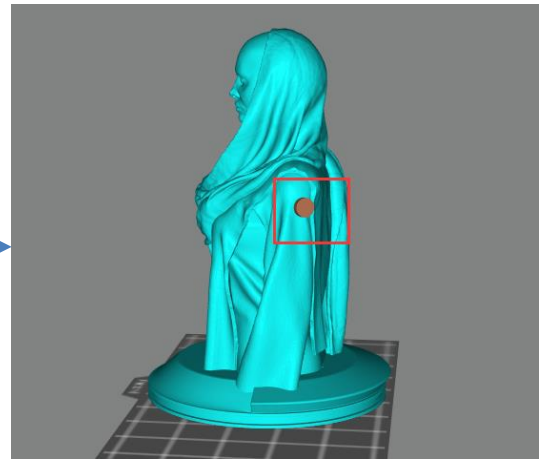

Left click on the model

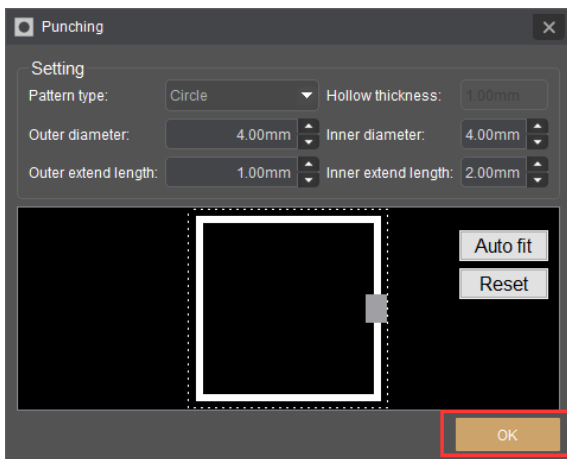

Click "OK" to finish

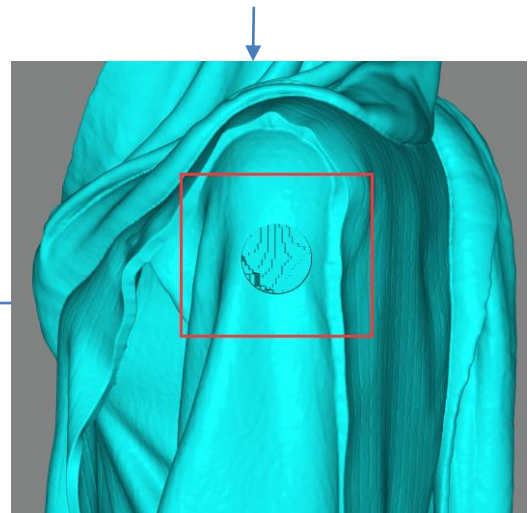

The model name: MIA

The author of the model: Fabio Nishikata

## (6) Text Paste

You can paste text on the model with this feature.

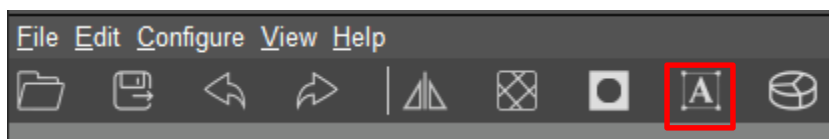

# Slicing Software

- Add mode

① Set the text style.

② Input the text.

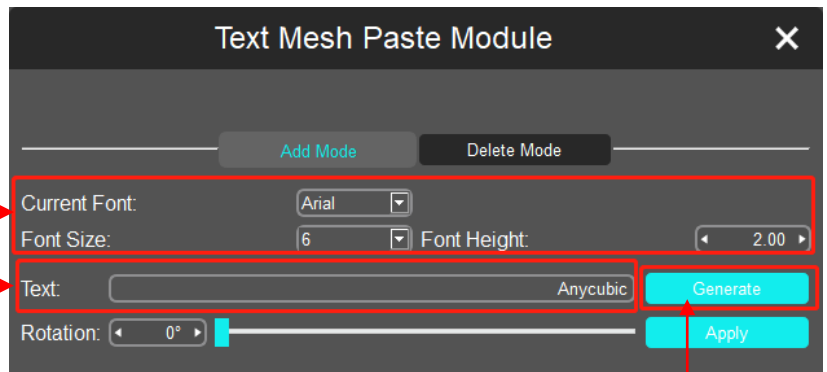

③ Click to generate mesh.

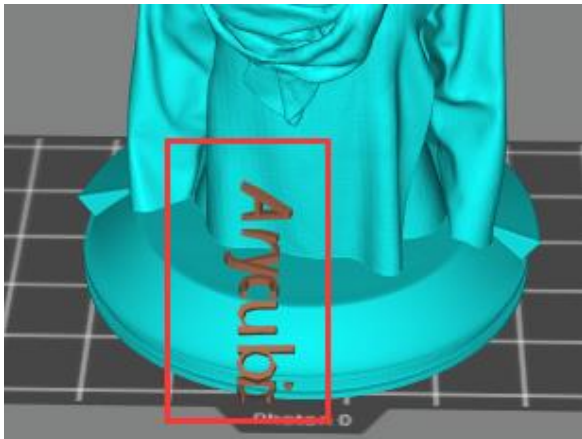

④ Left click on the model.

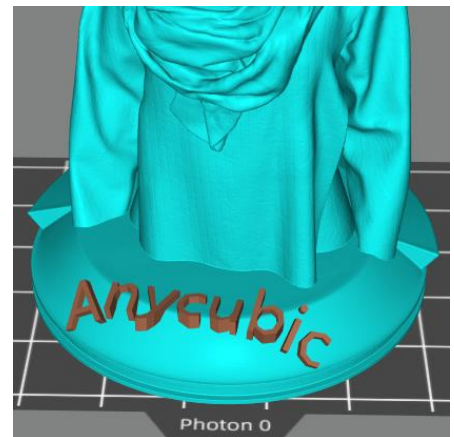
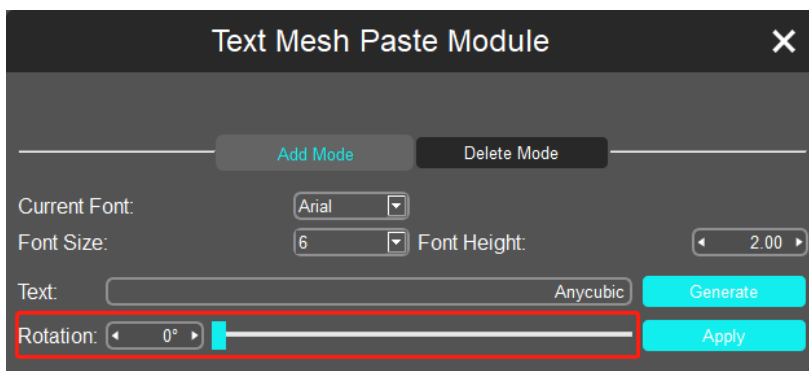

⑤ Drag the slider or input the number to rotate the text.

# Slicing Software

- **Delete mode**

① Switch to the delete mode.

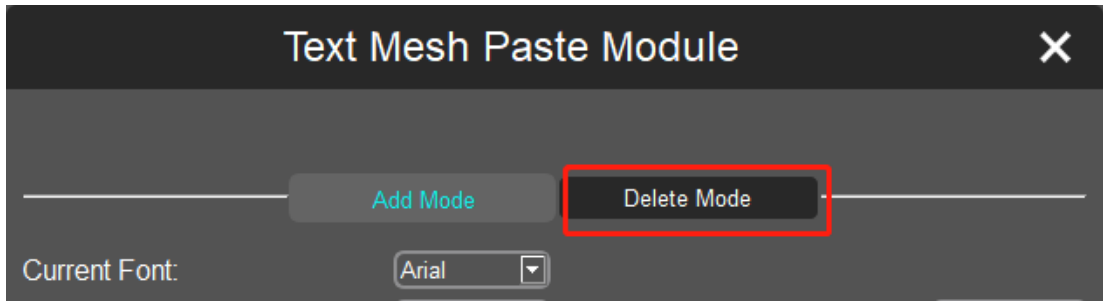

② Click the text and then click "Delete selected" to delete it.

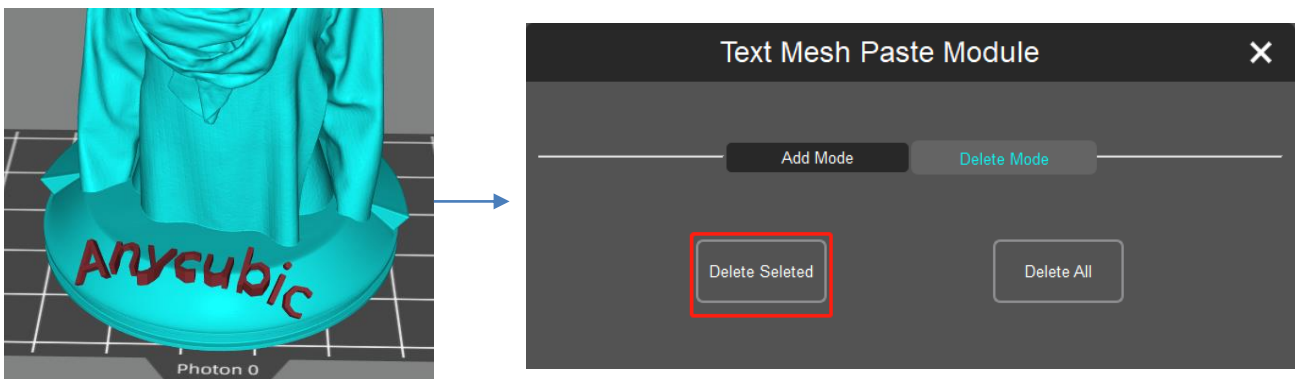

③ Click "Delete All" to delete all texts added before.

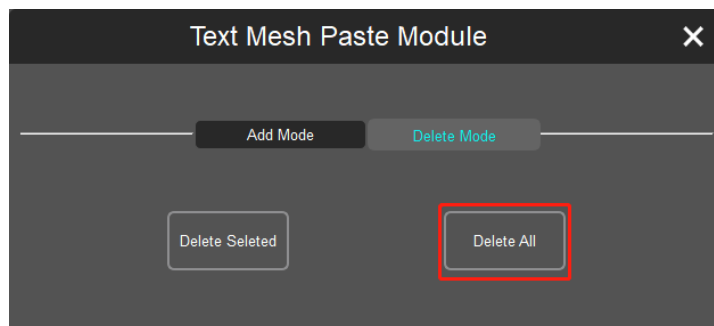

## (7) Split model

You can split the model into several parts and then cut off the unwanted parts.

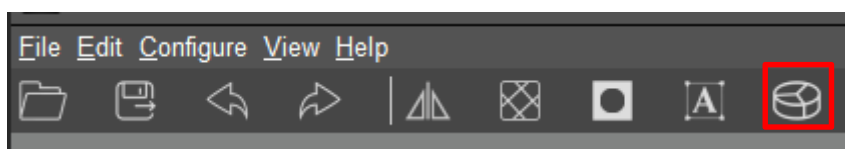

# Slicing Software

① Click the split icon, as shown in the red square above. Then make a cut across the model.

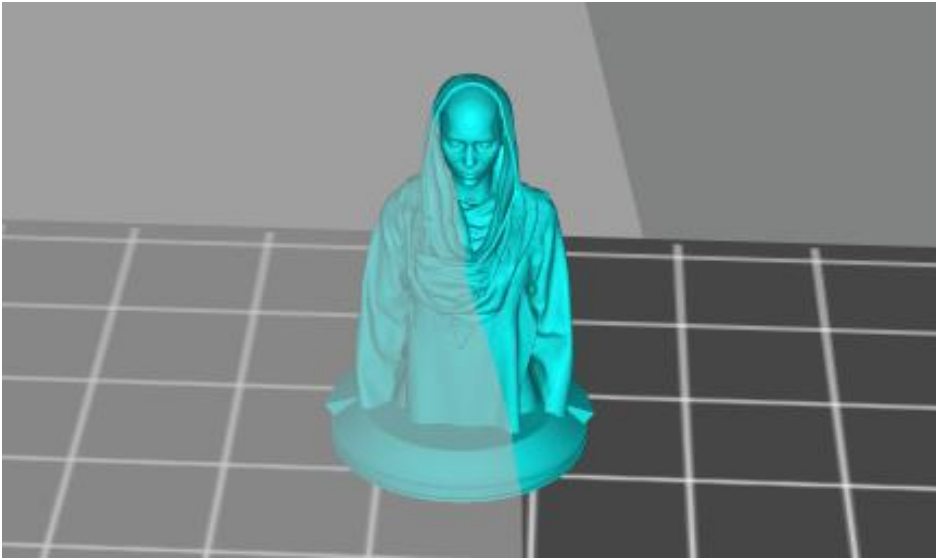

② Drag the slider to rotate the cutting surface along the XYZ axis. Then click “Generate Groups” after adjusting the cutting surface.

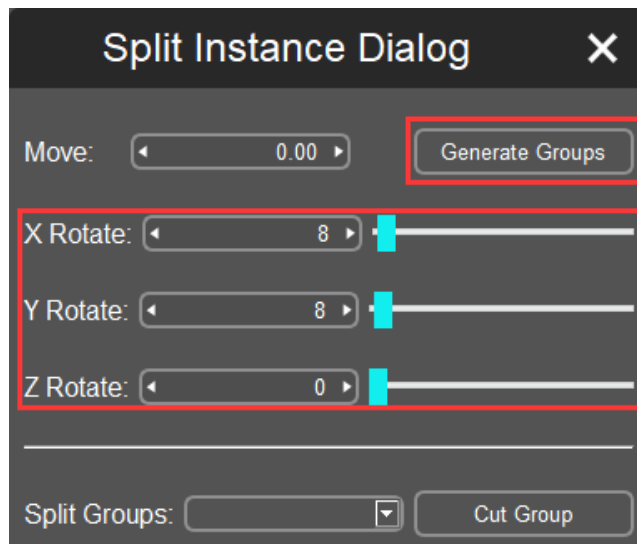



# Slicing Software

③ Select the unwanted group from the "Split Groups". The selected group will be shown in red in the model. Click "Cut Group" to remove it.

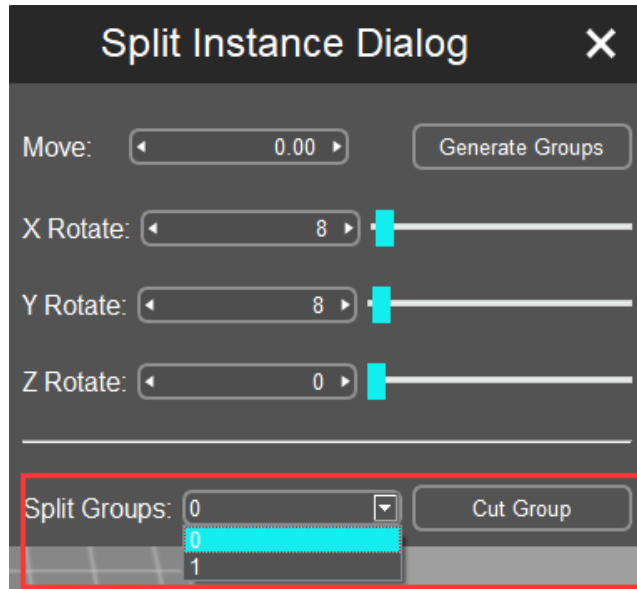

④ The effect picture after splitting the model.

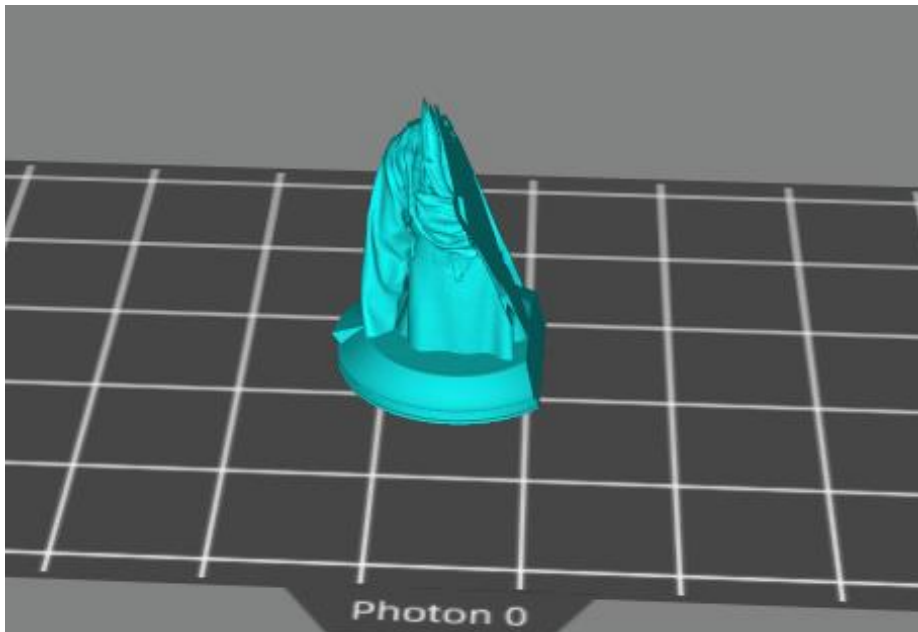

# Slicing Software

## (8) Support Settings

When the model has obvious suspended parts or overhang, it needs to add support to minimize the printing failure.

Click on the model and then click support tab to edit the support for the model.

Before adding support, you can edit the shape of the support.

There are three types of support, Light, Medium and Heavy.

**Light:** Contact area between the support and model is small, and the support is easy to remove;

**Heavy:** Support contact with the model area is large and solid.

**It is recommended to try the “Medium” first, and use the default settings.**

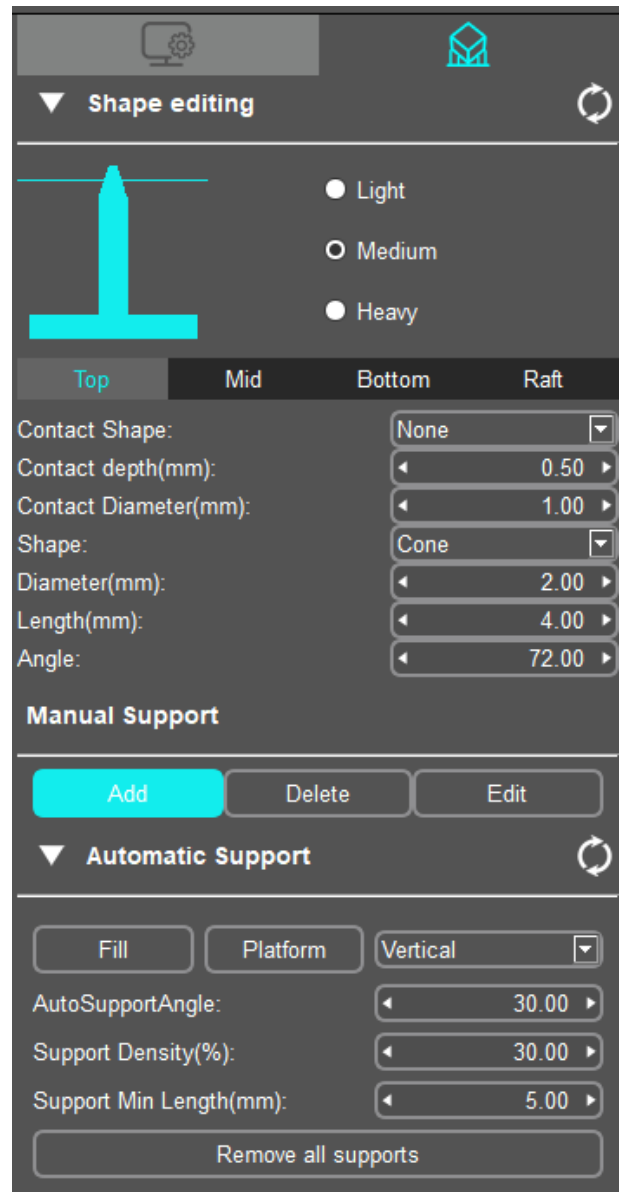

And you can always modify the support settings to fit your requirement.

# Slicing Software

## Step 1: Shape editing

Click on one of these types, such as Medium. As shown below, the support is divided into three parts, namely "top", "middle" and "bottom". The settings of those three parts are described in detail below.

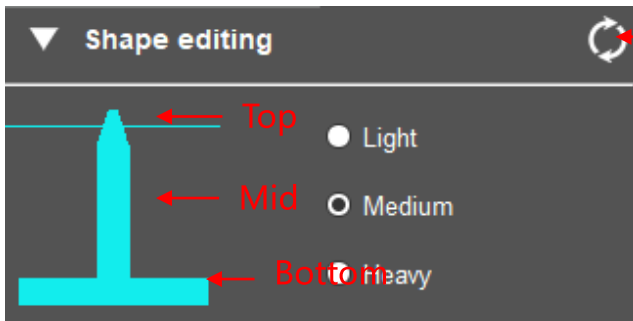

Click to refresh to preset parameters

① **Top:** Set the parameters for the top of the support.

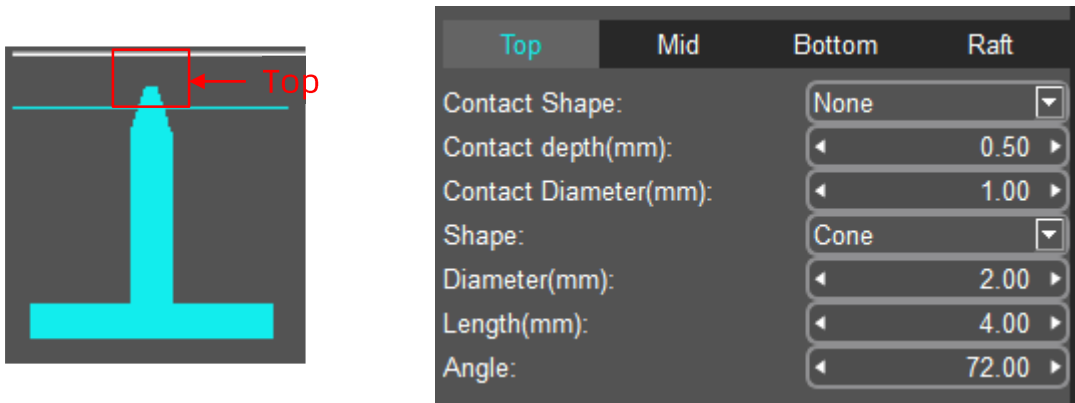

**Contact Shape:** Select the "Sphere" as the contact point between the top and the model can increase the contact area between the support and the model.

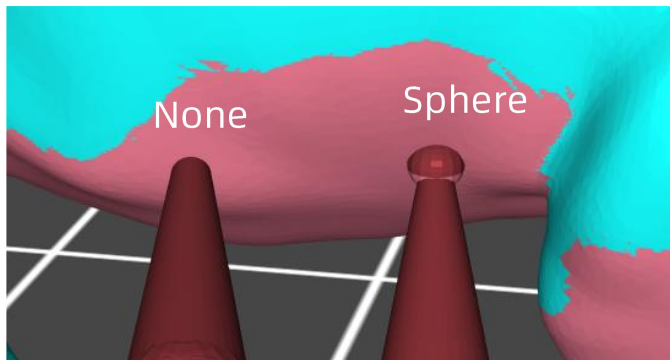

The author of the model: ZenMaster\_Maker

# Slicing Software

**Contact depth:** The contact depth between the support top and the model.

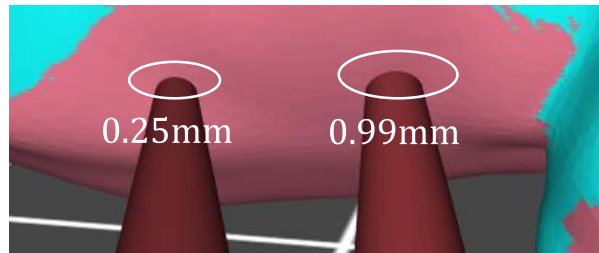
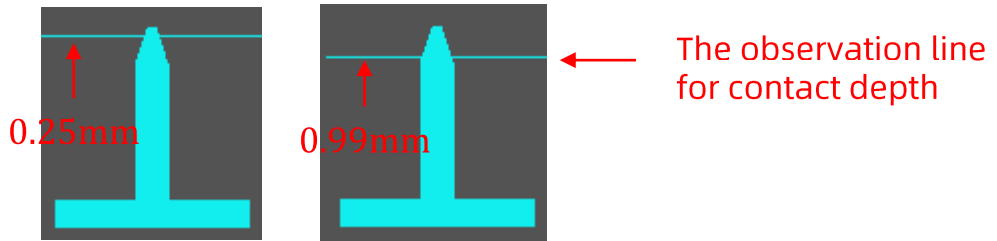

**Contact Diameter:** The contact diameter is valid when the contact shape is "Sphere".

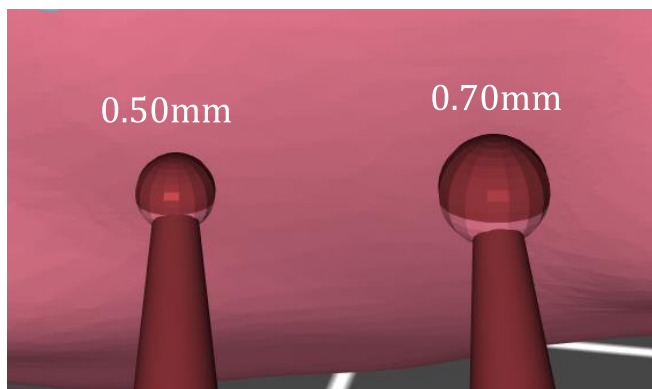

**Shape:** There are two options for the top shape, "Cone" and "Pyramid".



# Slicing Software

**Diameter:** You can input number to change the top diameter.

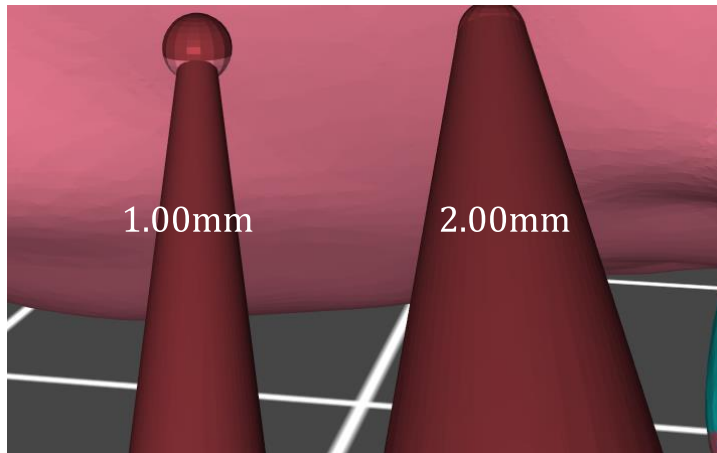

**Length:** You can input number to change the top length.

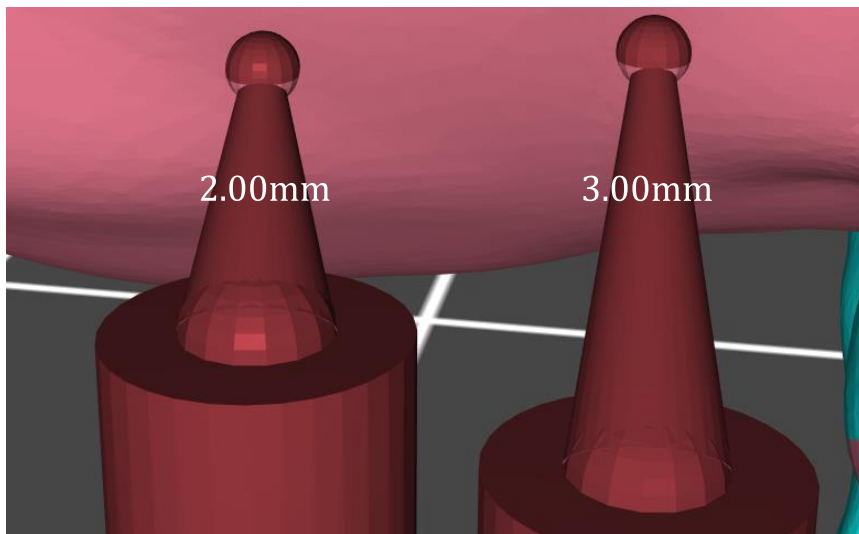

**Angle:** Use the default parameter.

② **Mid:** Set the parameters of the mid of the support.

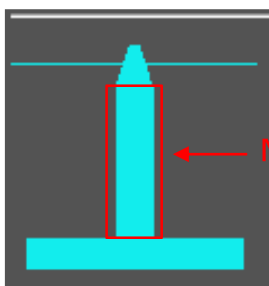

# Slicing Software

**Shape:** There are three options for the mid shape, "Cube", "Cylinder" and "Prism".

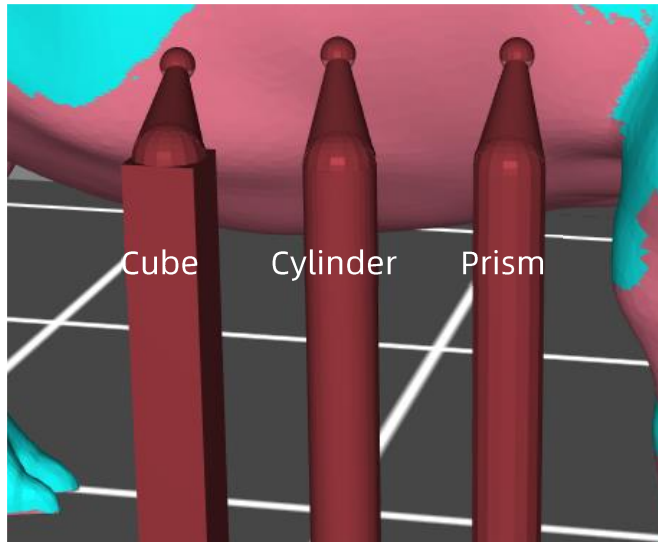

**Diameter:** You can input number to change the mid diameter.

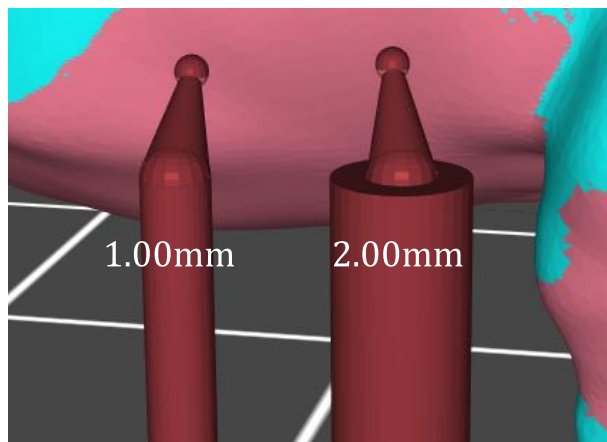

③ **Bottom:** Set the parameters on the bottom of the support.

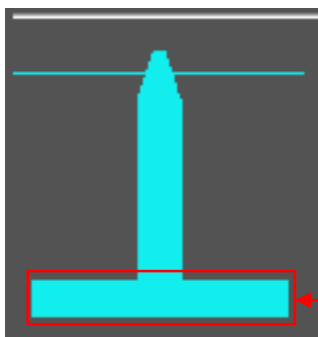

Bottom

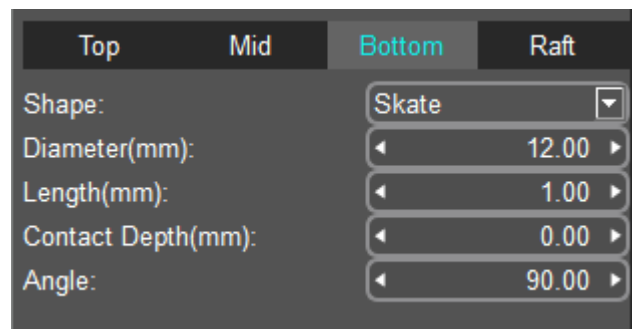

# Slicing Software

**Shape:** There are four options for the top shape, "Skate", "Cube", "Cylinder" and "Prism".

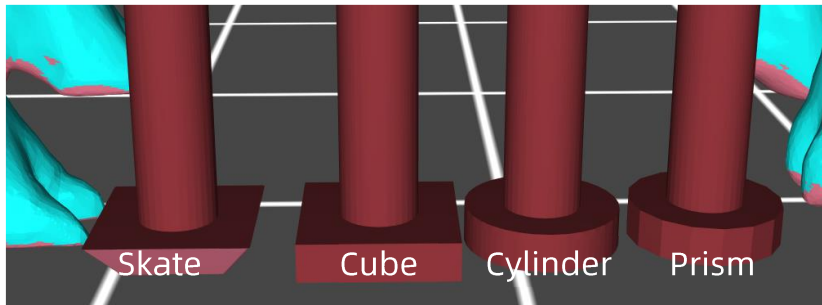

**Diameter:** You can input number to change the bottom diameter.

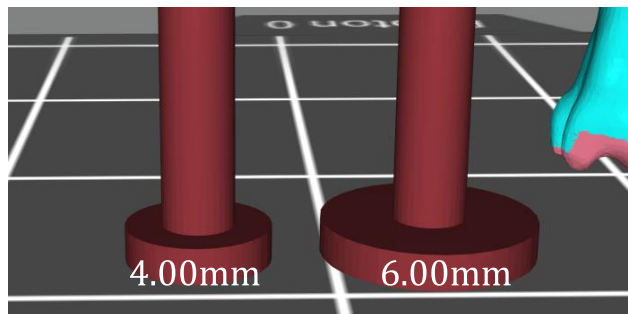

**Length:** You can input number to change the bottom length.

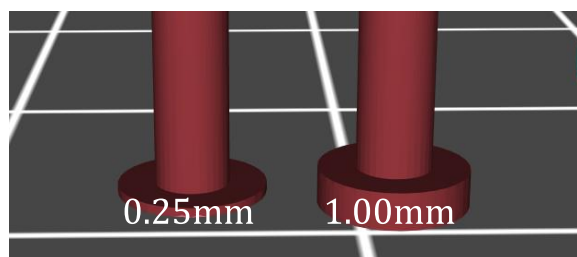

**Contact Depth:** The depth of contact between the bottom of the support and the model when the support is added inside the model.

**Angle:** Use the default parameter.

# Slicing Software

## ④ Raft

In addition to the three types of supports set by software, raft can be added to the model. Adding raft will increase the adhesion between model and build platform, thereby minimizing the print failure or warping risk.

Select the shape of the raft as "Skate" and click "Fill" or "Platform" to add the raft and support.

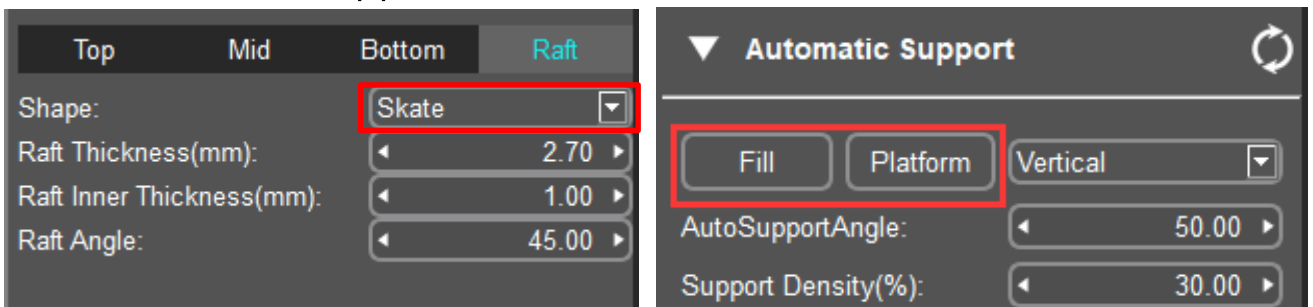

Note: Before adding the raft, you need to lift the model up by a certain height in the z-axis direction.

- Lift the model up by 5mm (suggested) in the z-axis direction:

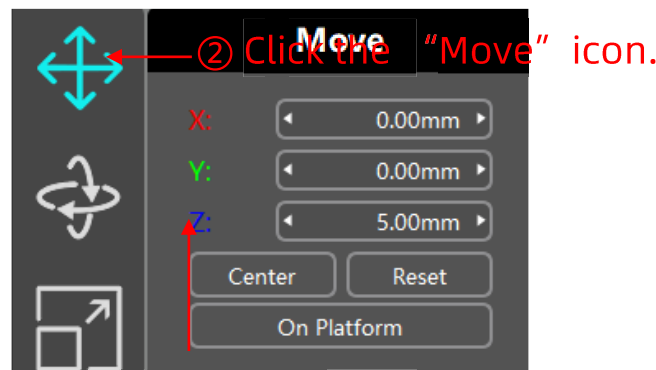
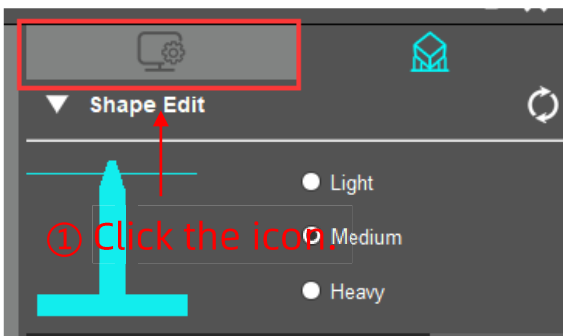

After lifting the model up, click the "  " icon to add support.

## Step 2: Support adding

You can add the support to the model manually or automatically after setting up the shape of the support.

Note: The automatic support will override all the previously set supports.



# Slicing Software

## ① Manual Support

**Add:** Only after click the "Add" button then can you add the support to the model.

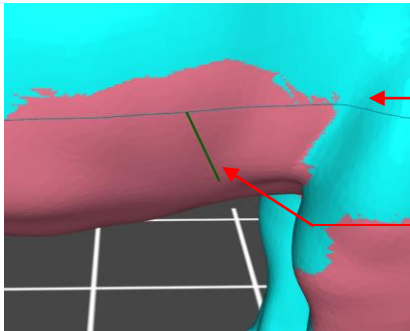

contour line, it can be used as reference line when you are adding support

When the mouse moves on the model, the green short line can be clicked to add support; the red short line means it cannot be clicked to add support

**Delete:** Click the "Delete" button and then click the support on the model and click "Delete" button to remove the support.

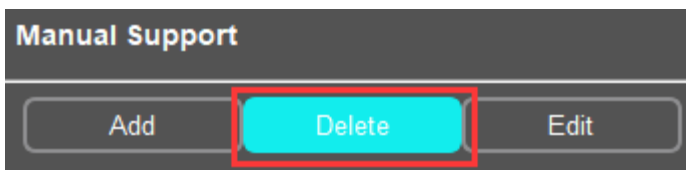

①

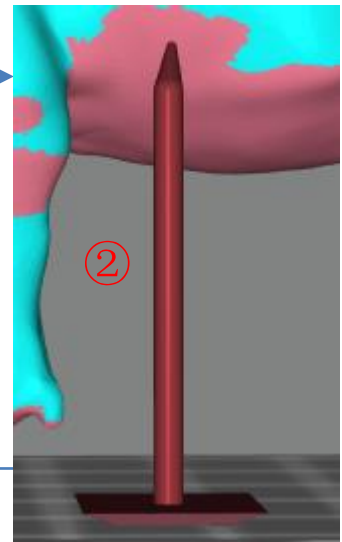

②

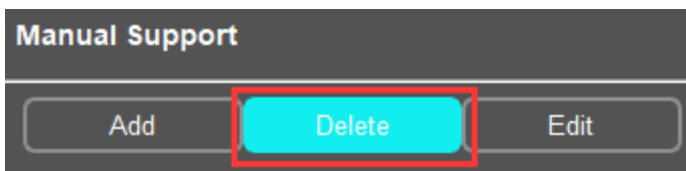

③

**Edit:** The support can be edited after clicking the "Edit" button. Click the support, it will become red. Its shape can be changed through editing the top, mid and bottom parameters. Besides, left click the model, hold on and move the mouse can change the position of the support.

# Slicing Software

## ② Automatic Support

After setting "Auto Support Angle", "Support Min Length" and "Support Density", click "Fill" or "Platform" can automatically add supports for the model.

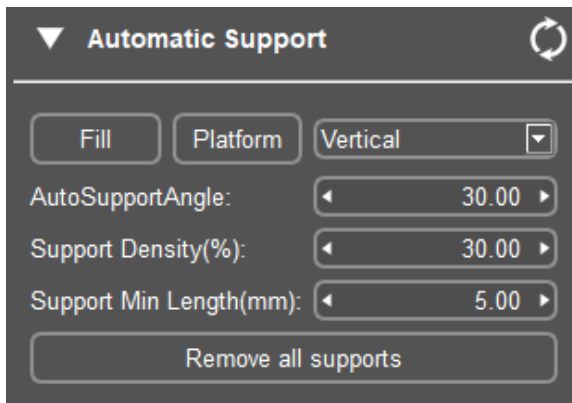

Click to refresh to the preset parameters

**Auto Support Angle:** The tangent angle between the model (small triangular facets) and the printing platform.

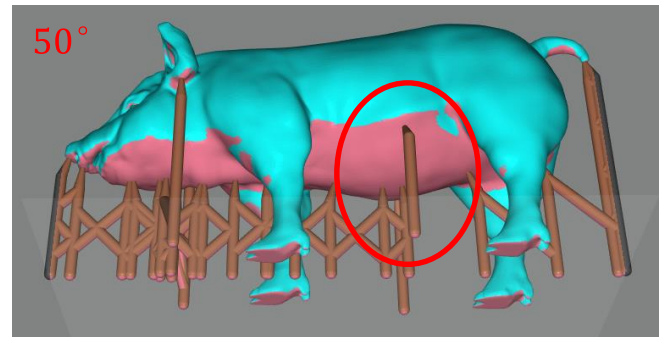
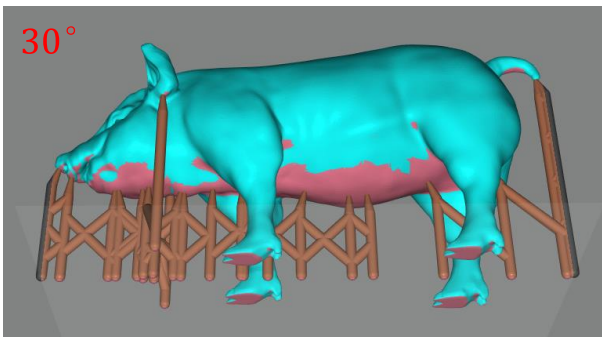

With the same "Support Density", the larger "Auto Support Angle" is, the more supports can be added.

**Support Density:**

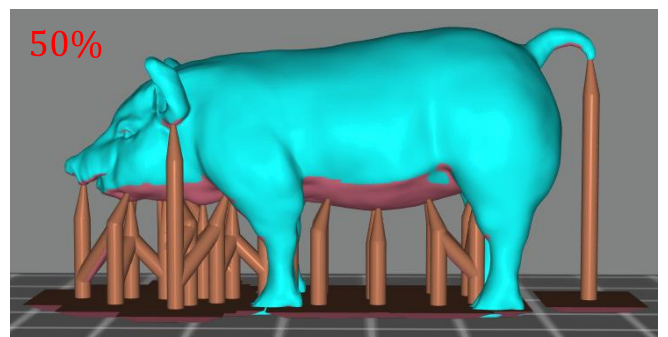
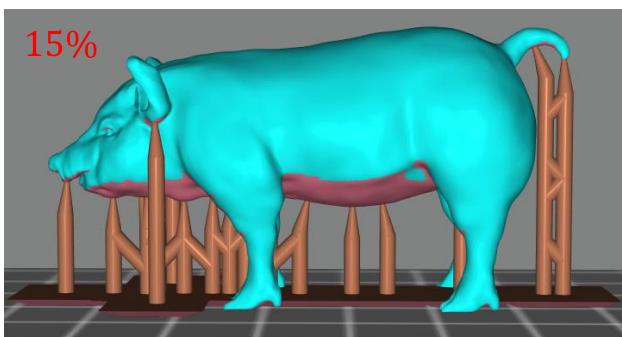

The author of the model: ZenMaster\_Maker

# Slicing Software

**Support Min Length:** Use the default parameter.

There are two types of supports added automatically, "Vertical" and "Tree".

When you choose "Tree" type, the supports can be combined and interlocked. It simplifies the supports and saves material.

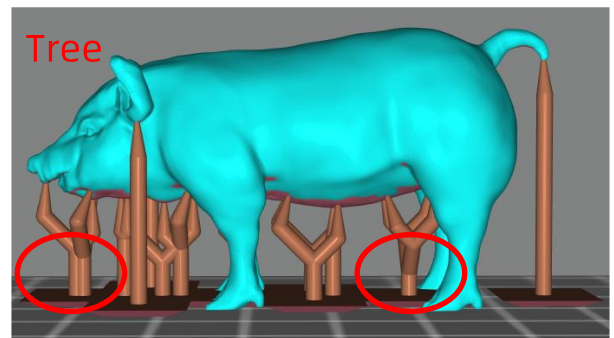
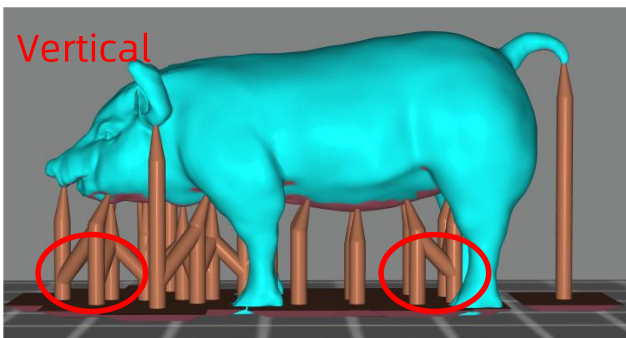
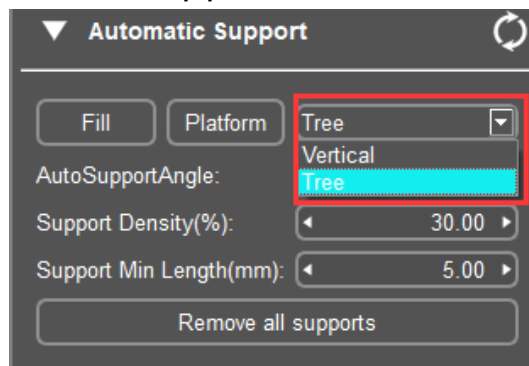

After setting each parameter, click the "Fill" or "Platform" button to automatically add support.

- "Fill": The support can be added between the platform and the model, and between the model and the model.
- "Platform": The support only can be added between the platform and the model.

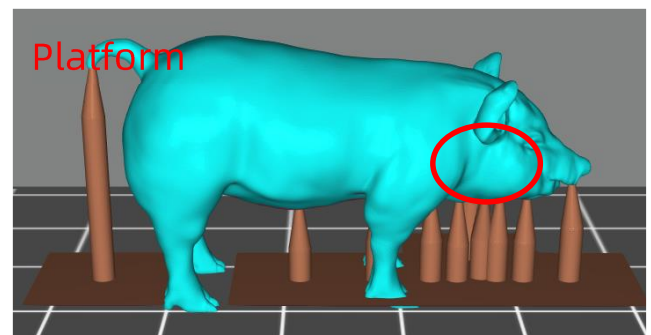
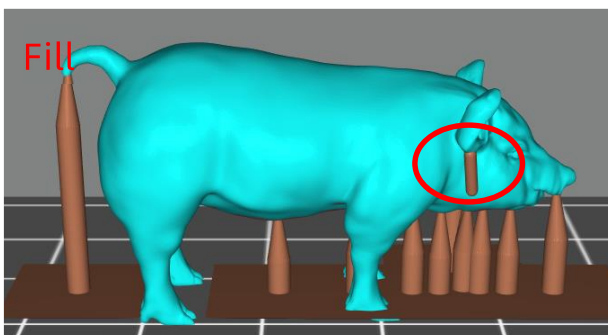

# Slicing Software

## ③ Automatic support adding skills (improve print success rate)

**Tip 1:** Properly increasing the support angle and density can optimize the support results and deliver better print quality.

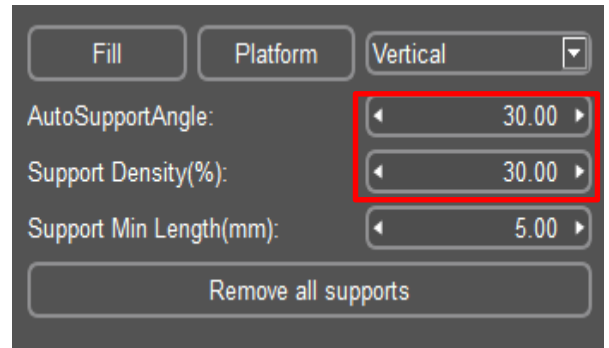
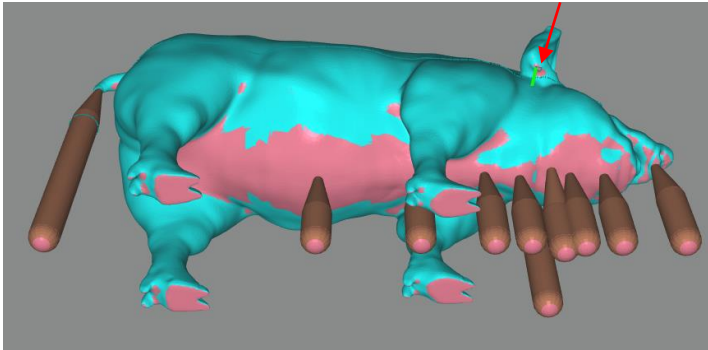

When browsing on the model, by observing the contour circle, it can be found that the model still has some weak points that have not been added supports properly (highlighted by **red arrows**).

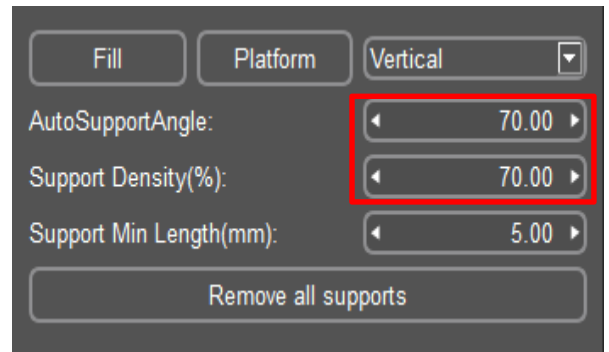
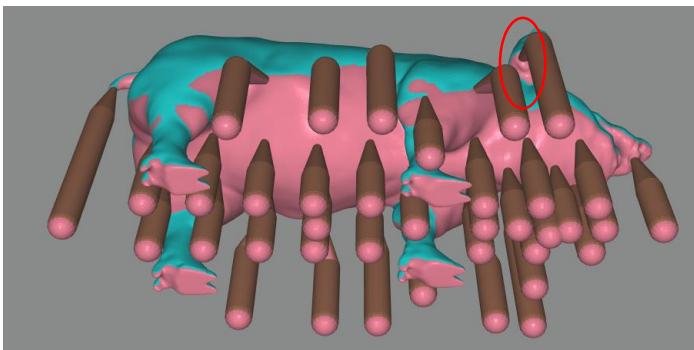

If we increase the automatic support angle and support density (highlighted by **red square**), we can see from the picture below that more supports have been added to some of the weak points.

**Tip 2:** Manual support after Auto support (use the contour to find the weak points, add support to the local lowest point by checking the contour circle)

# Slicing Software

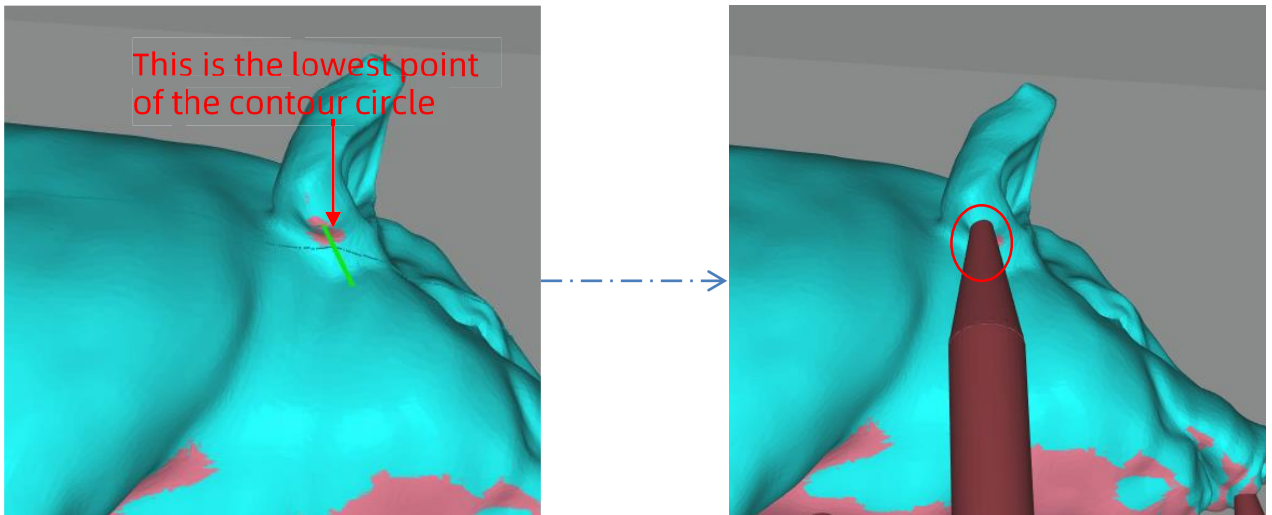

## (9) Parameter Settings

### ① Slice Settings

The default printing mode is "Normal Mode". In the slice settings, four resin types are preset—"Basic", "Plant-based", "Dental Castable" and "Custom". Different Resin Types have different printing parameters. You can directly select the "Resin Type" according to which Anycubic Resin you use.

Resin Type:	Basic	▼
Resin Price:	218.00	¥ ▼
Resin Volume(ml):	500.00	
<hr/>		
Layer Thickness(mm):	0.050	
Normal Exposure Time(s):	2	
Off Time(s):	0.50	
Bottom Exposure Time(s):	40.00	
Bottom layers:	6	
<hr/>		
Z Lift Distance(mm):	◀ 8.00 ▶	
Z Lift Speed(mm/s):	◀ 2.00 ▶	
Z Retract Speed(mm/s):	◀ 3.00 ▶	
Anti-alias :	1	▼

# Slicing Software

You can always modify the parameters.

And, you can add custom resin type. Click "Configure" → "Resin Manage".

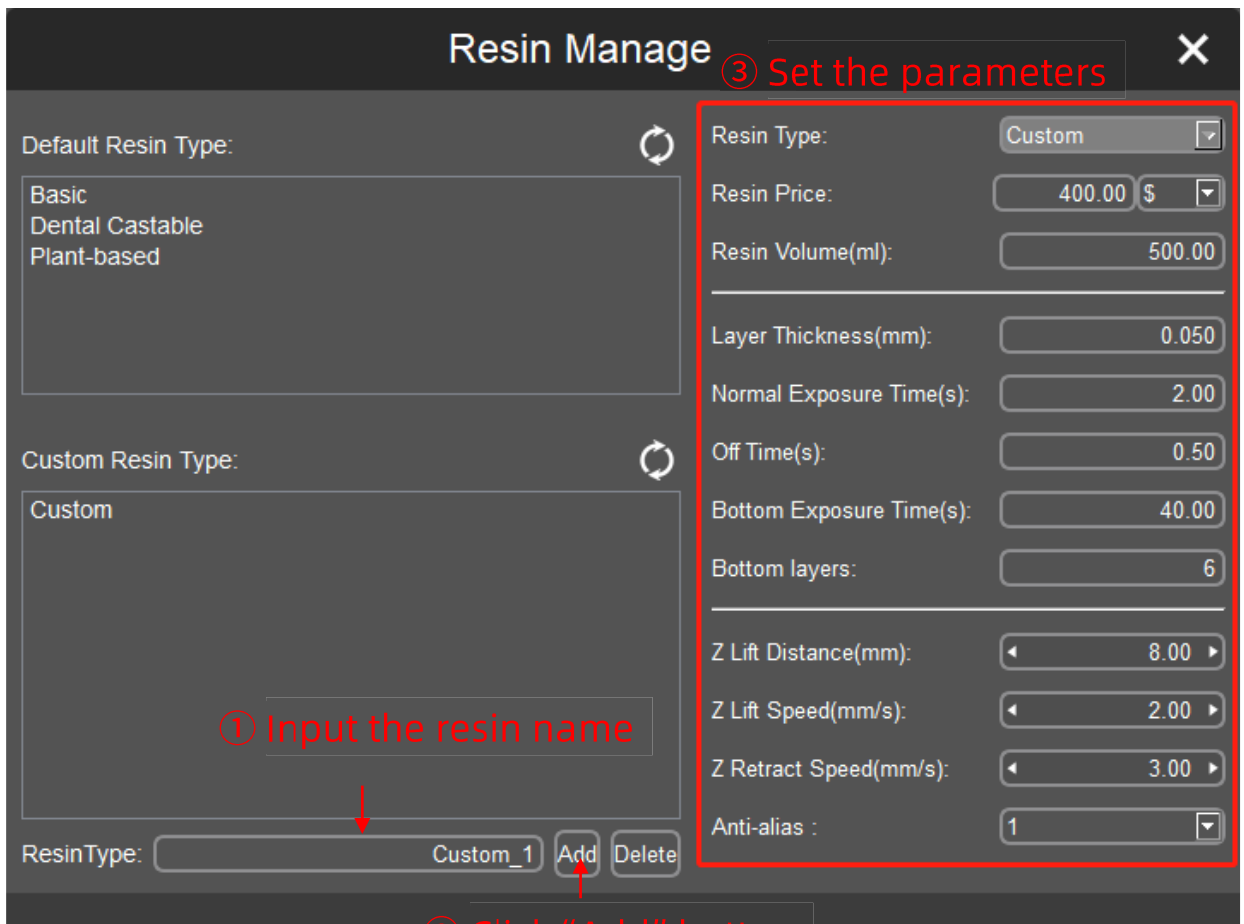
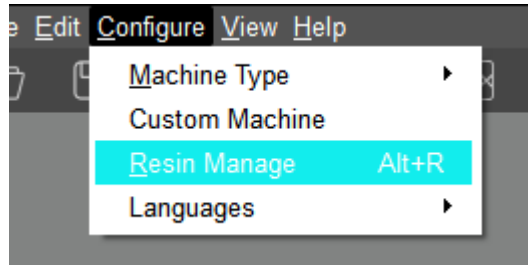

Note: Click refresh icon can restore the default parameters of the resin.

# Slicing Software

---

## Slice parameters:

- ① **Resin Price:** Set the price according to the purchased resin.
- ② **Resin Volume:** Set according to the volume of a bottle of resin you purchased. During slicing, it will automatically calculate the resin consumption and price in total.
- ③ **Layer thickness:** The thicker the layer, the longer the exposure time for each layer.
- ④ **Normal exposure time:** Setting range: 0.5~4s, the exposure time is set according to the thickness of each layer, the complexity of the model details and the resin materials.
- ⑤ **Off time:** The UV light interval between each layer is ranged 1~6s.
- ⑥ **Bottom Exposure Time:** Setting range: 30~80s, the longer the bottom exposure time is, the easier the bottom layer of the model stick onto the build platform.
- ⑦ **Bottom layers:** Setting range: 6~12.
- ⑧ **Z Lift Distance:** It is suggested to set it to 8mm.
- ⑨ **Z Lift Speed:** It is suggested to set it to 2mm/s.
- ⑩ **Z Retract Speed:** It is suggested to set it to 3mm/s.
- ⑪ **Anti-alias:** A higher grade of anti-alias value could enhance the ability to smooth the edges for each layer during printing, thereby resulting better surface of the printed objects. A higher grade of anti-alias value also means longer slicing time and larger files. The suggested value is 8.

# Slicing Software

## ② Machine Settings

These parameters seldom need modification. But if the printed model shows big dimensional error along a particular axis (X,Y or Z), you can modify the corresponding values for that axis proportionally.

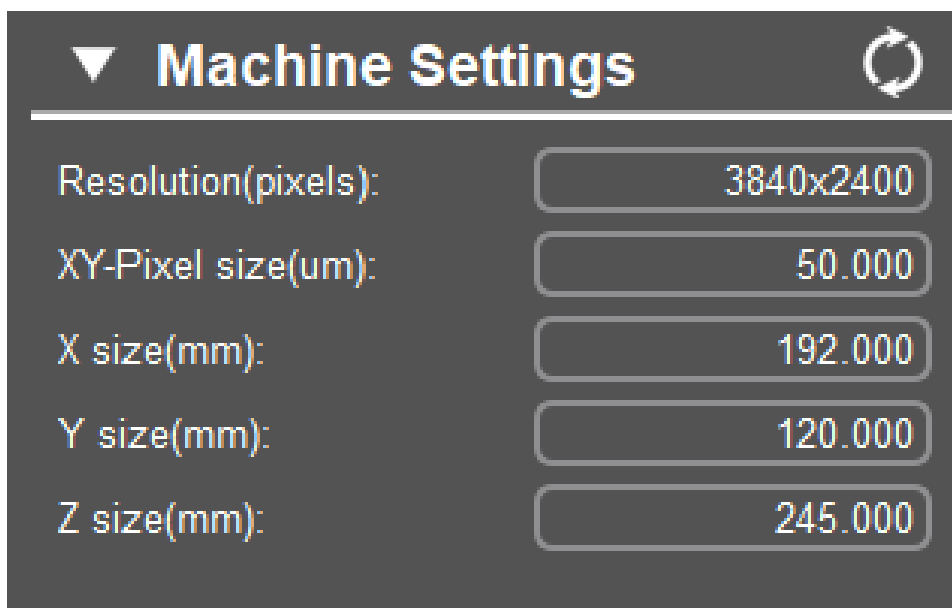
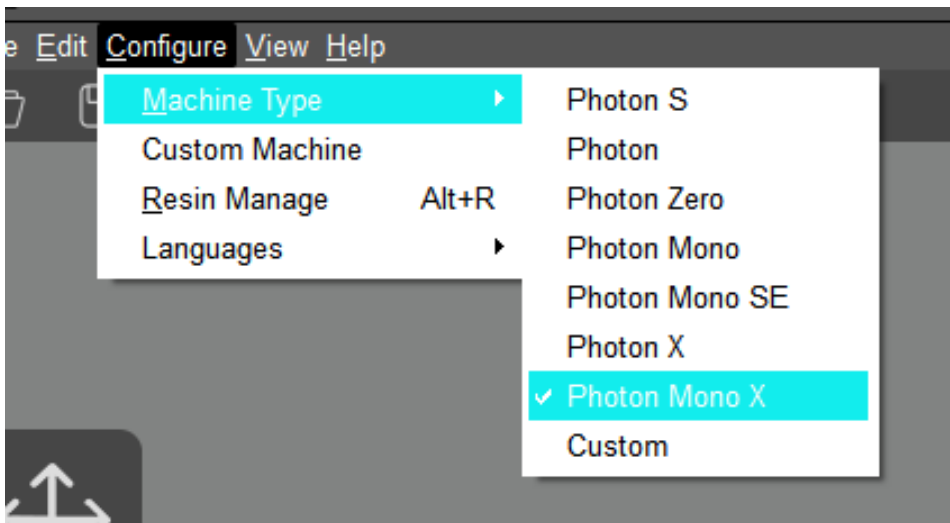



# Slicing Software

## (10) Slicing

After confirming the slice settings, click the "Slice" icon at the top left (red square). You need to save the sliced file as ".pwmX" so the Photon Mono X would recognize the file.

Choose the file directory and save the ".pwmX" file in the memory stick and then start slicing, and click OK to finish. You may click "Preview" to check each layer and the corresponding parameters.

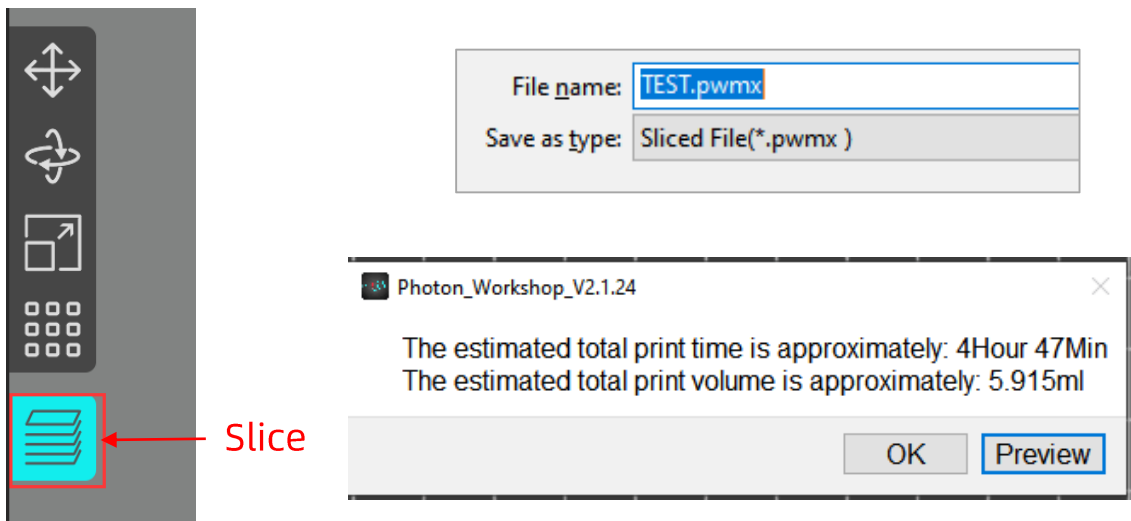

In the slice file view interface, you can preview related slice settings, machine settings, single layer settings and other information.

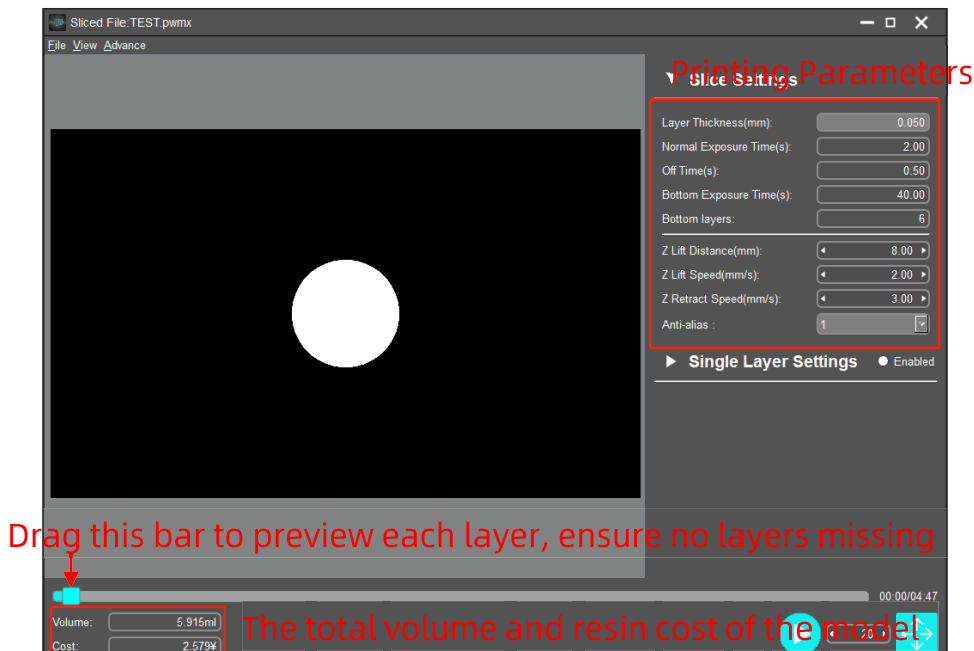

# Slicing Software

In the Sliced File View interface, check “Enabled” to set the exposure time, Z lift distance and Z lift speed of the current layer according to personal requirements. Upon finished, click “File” → “Save File” on the upper left corner to save it as a new sliced file.

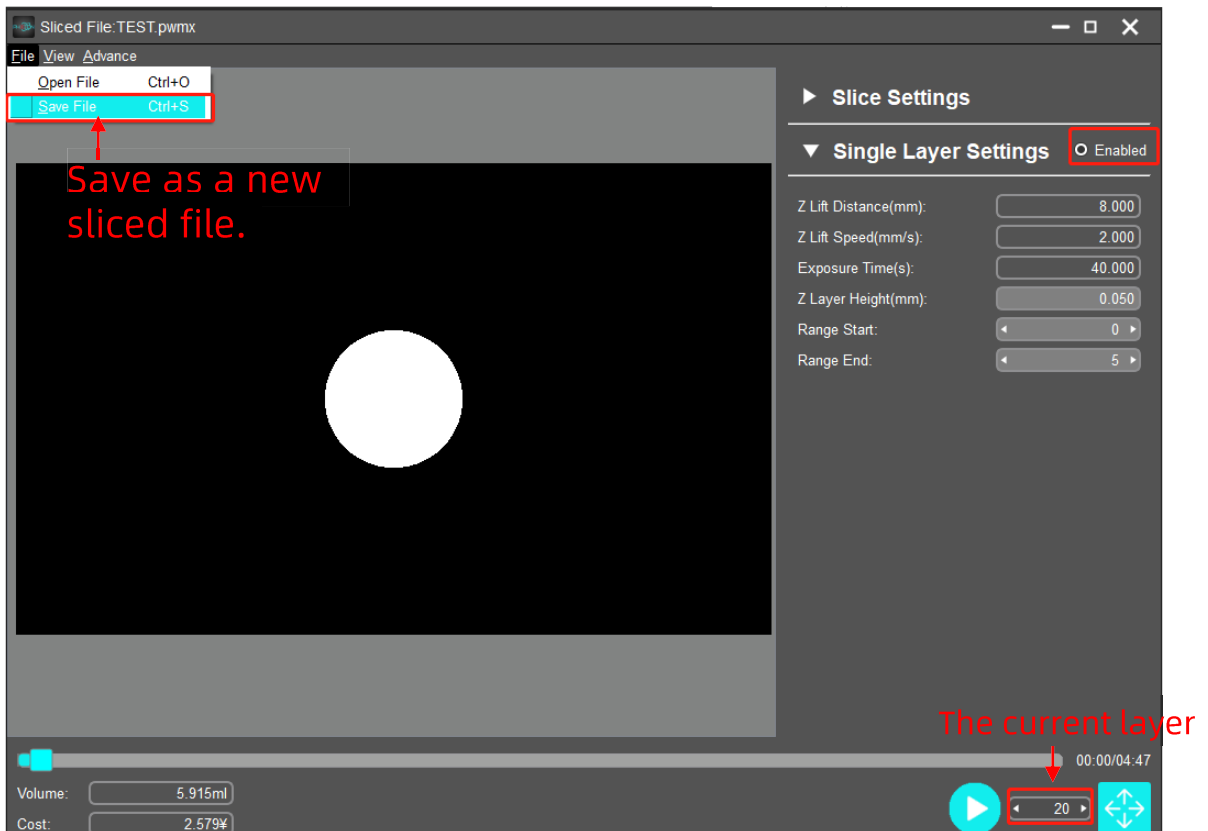

## Note:

1. This function is invalid for the bottom layers. Do not use this function to bottom layers.
2. After changing the individual layer settings, the exposure parameters of the new file cannot be modified again via the printer touch screen during printing. Even if it has been modified, the change would only be valid for the current layer.

# Slicing Software

## (11) R\_E\_R\_F

“R\_E\_R\_F” is an abbreviation for “Resin Exposure Range Finder”. This function is used to find out the optimal exposure parameters for different resins.

Import the “R\_E\_R\_F.pwm” file into the slicing software (The file has been saved into the memory stick). Specifically, in the R\_E\_R\_F mode, the curing screen will be divided into eight areas and each area is numbered, as shown in the picture.

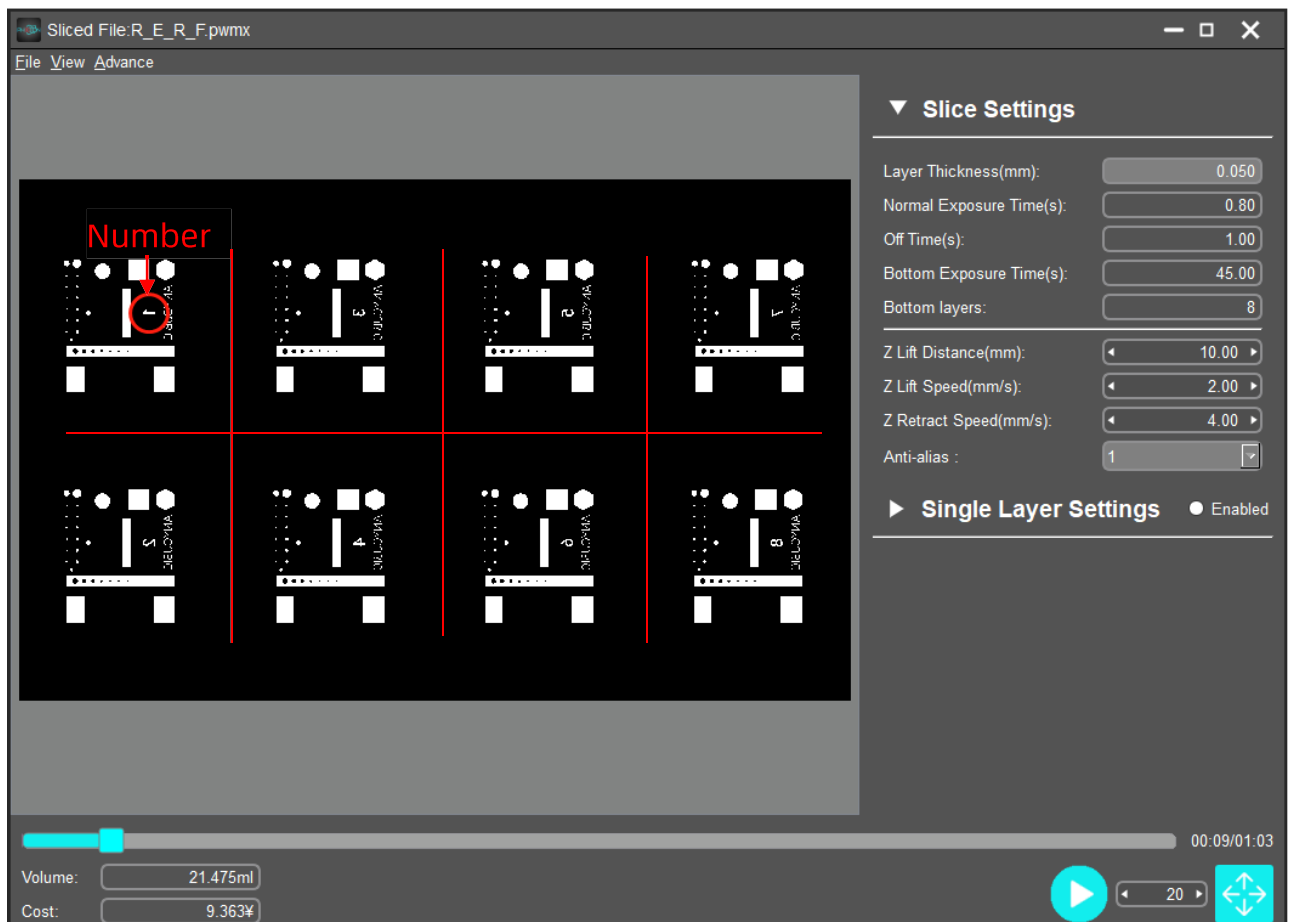

# Slicing Software

---

- The exposure time for Area No.1 is equal to "normal exposure time (s)" in the slicing settings (exclude Bottom Exposure Time), and the exposure time for other areas will be increased by an increment of "0.4s" subsequently.
- For example, when "Normal Exposure Time (s)" is set to 0.8s in the slicer, the exposure time for Area No.1 is 0.8s, the exposure time for Area No.2 will be 1.2s, and so on, and the exposure time of Area 8 will be 3.6s.
- You can modify the exposure time of Area No.1 by modifying the "Normal Exposure Time (s)" parameter, and this action is also valid during printing.

The normal exposure parameter of "R\_E\_R\_F.pwmX" file attached to memory stick is 0.8, and users can print this file directly for testing.

After printing, take off the model, wash it with ethanol 95vol% concentration, and then observe it. The exposure parameters of the model with the best printing effect are the best exposure parameters of the resin.

## Note:

DO NOT change the file name of "R\_E\_R\_F" , because the Photon Mono X can only recognize THIS file name to run this function. Also, do not name other unrelated file as "R\_E\_R\_F" .

# FAQ and Machine Maintenance

## 1. FAQ

### (1) Model do not stick to platform

- Bottom exposure time is insufficient, increase the exposure time.
- Contact area between the model and platform is small, please add raft.
- Bad leveling

### (2) Layer separation or splitting

- The machine is not stable during printing
- FEP film in the vat is not tight enough or it need a change for new one
- The printing platform or vat is not tightened

## 2. Machine maintenance

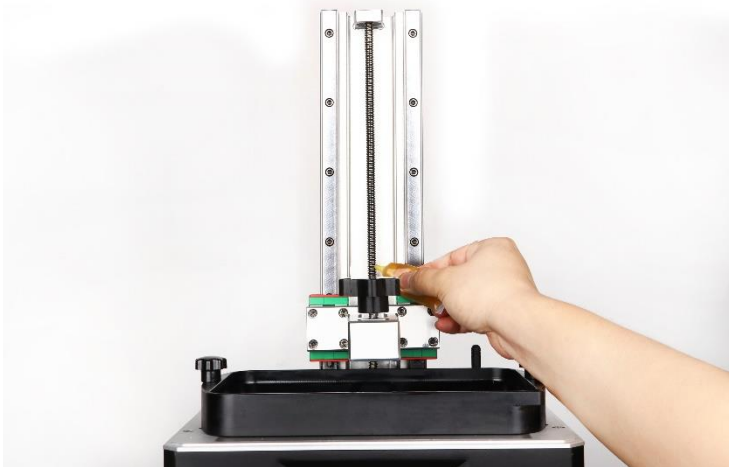

(1) If Z axis make noisy sound, please apply lubricant to Z lead screw.



(2) Do not use sharp objects to scrape off the residues on the FEP film.

# FAQ and Machine Maintenance

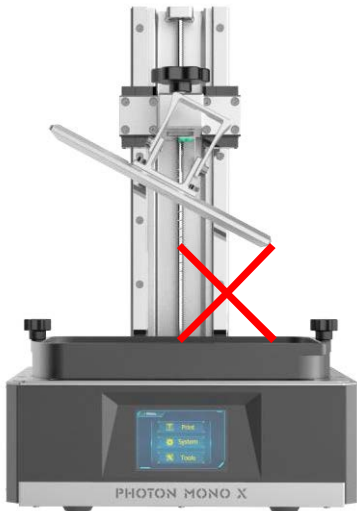

(3) Be careful when remove the platform, do not let it fall onto the curing screen.

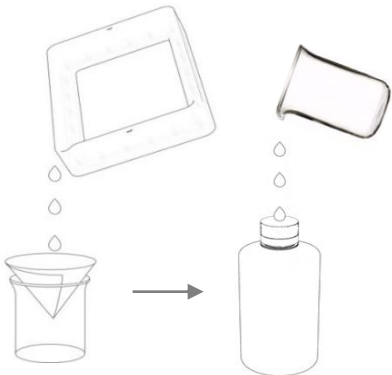

(4) Do not left the resin in the vat for over two days if do not use it. Please filter and store the resin properly.

(5) After printing, please clean up the platform (**wipe clean with paper towels or wash with alcohol**), and ensure no residue left before next print (**filter the residue with funnel**).

(6) If the outside of printer is stained with resin, use alcohol to wipe clean.

(7) To switch the resin colors, please clean the original resin vat first.

Thank you for purchasing ANYCUBIC products! Under normal usage and service, the products have a warranty period up to one year. Please visit ANYCUBIC official website([www.anycubic.com](http://www.anycubic.com)) to report any issue with ANYCUBIC products. Our professional after-sale service team would respond within 24 hours and solve the issues.